



Ersatzteile & Zubehör
Handels GmbH.

STEYR



Ihr Partner, wenn
es um Ersatzteile geht!

Oberharrern 33
A-4691 Schlatt

Tel.: 0043 (0)7673 / 30703

Fax: 0043 (0)7673 / 30703-40

email: verkauf@oekoprofi.com

www.oekoprofi.com

AKTION

gültig vom 13.06. bis 12.07.2026

Grammer Luftsitz Maximo L

- luftgefederter Komfortsitz 12V
- ohne Rückenverlängerung
- mit höhenverstellbaren und klappbaren Armlehnen
- Armlehnen-Länge 260 mm • Federweg: 100 mm
- Gewichtseinstellung manuell
- Höheneinstellung: 80 mm, stufenlos
- Längseinstellung: 210 mm
- Längs-Horizontal-Federung
- Lendenwirbelstütze mechanisch
- Rückenlehnen-Neigungsverstellung
- Sitzkissenbreite: 480 mm
- Stoffbezug, schwarz

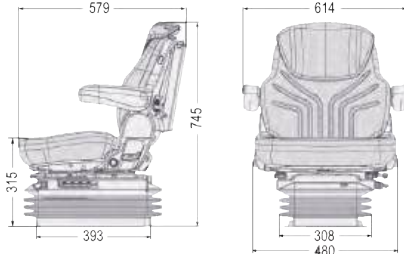

Zustellung
€ 30,-

Nr.	Bezeichnung	€
G5300	Grammer Luftsitz MAXIMO L	799,00 739,00

Komfort-Gesundheitssitz

mit Luftfederung Ökoprofi

- Längsverstellung 190 mm
 - Federweg 140 mm
 - Mit Hydraulik-Stoßdämpfer
 - Automatische Gewichts- und Höheneinstellung, 50 - 130 kg
 - Horizontal-Federung mit Dämpfer (35 mm Federweg)
 - Rückenlehne Neigungsverstellung 30°
 - Mechanische Lendenwirbelstütze
 - Polyurethan-Sitzkissen
 - verstellbare Armlehnen
 - Feuerfeste Stoffbeschichtung
 - Verlängerbare Rücklehne
 - Luftkompressor 12 V
- Aufbau: Alle Metallteile sind mit Elektrophorese grundiert und elektrostatisch einbrennlackiert.
Bolzen, Schrauben, Muttern, Unterlegscheiben und Ringe sind korrosionsbeständig.

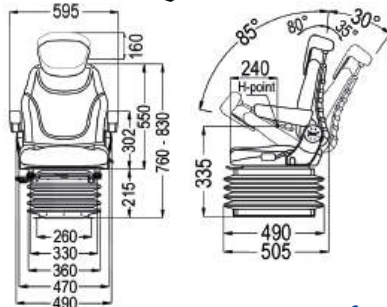

Nr.	Bezeichnung	€
87630	Gesundheitssitz mit Luftfederung Ökoprofi (12V Luftkompressor 9 A) (ohne Armlehne, Rückenverlängerung und Sicherheitsgurt)	849,00 749,00

Zubehör

Nr.	Bezeichnung	€
87633	Rückenverlängerung zu 87630	73,90 61,60
53059	Armlehnenpaar verstellbar, zu 87630	89,90 74,90
53061	Sicherheitsgurt	35,90 29,90
62835	Sitzpolster zu 87630	104,90 87,40

Ökoprofi-Gesundheitssitz

- Längsverstellung 190 mm
- Rückenlehnen-Neigungsverstellung 30°
- Höhenverstellung 80 mm
- Lendenwirbelstütze
- Für Luftsitz: autom. Gewichtseinstellung
- eingebauter Kompressor 12V
- Horizontalfederung

Nr.	Bezeichnung	€
53001	Luftsitz Stoff schwarz (ohne Armlehne, Kopfstütze und Sicherheitsgurt)	769,90 689,00

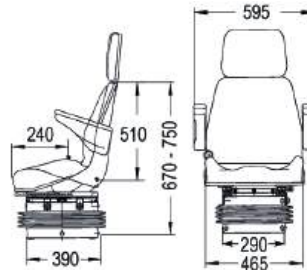

Zubehör

Nr.	Bezeichnung	€
53059	Armlehnenpaar verstellbar, zu 53001	89,90 74,90
53052	Kopfstütze	54,90 45,80
53005U	Sitzpolster Unterteil Stoff schwarz	88,90 74,10
53005O	Sitzpolster Oberteil Stoff schwarz	88,90 74,10

Universalsitz Ö1050

- Großer Federweg von 90 mm
- Hydraulischer Stoßdämpfer
- Gewichtsverstellung 50 - 120 kg
- Einstellbare Grundplatte: 0, 11 und 20 Grad

Nr.	Bezeichnung	€
96490	Universalsitz Ö 1050	498,80 165,70

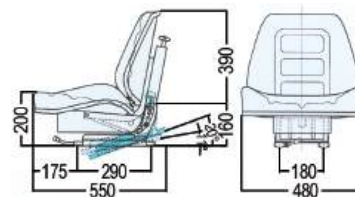

Universalsitz Klepp Elastomat 600

- Federweg 80 mm
- Gewichtseinstellung stufenlos 40 - 120 kg

Nr.	Bezeichnung	€
53024	Sitz mechanisch gefedert Bezug Kunstleder schwarz passend zu Steyr Serie Plus	389,90 369,00



64564	Sitz mechanisch gefedert passend zu Steyr Serie Plus	259,00 239,00
-------	---	-------------------------



Traktorsitz zu Steyr Plus Serie

- Längsverstellung 150 mm
- Federweg 80 mm
- Gewichtseinstellung 50 - 130 kg

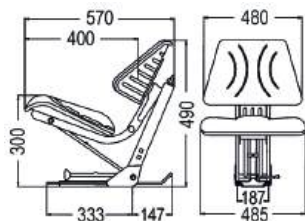

Nr.	Bezeichnung	€
80647	Sitz mechanisch gefedert passend zu Steyr Serie Plus	174,99 145,80

Schonbezüge

- 96346 Universalbezug groß**
• Sitzbreite/-tiefe: 54/47 cm
- 96347 Universalbezug mittel**
• Sitzbreite/-tiefe 52/42 cm

Passt für viele Traktoren und Baumaschinen. Besteht aus strapazierfähigem, anthrazit-farbenen Tweedmaterial und schützt den Originalsitz optimal vor Verschmutzungen und Abnutzung, was zum Werterhalt des Fahrzeugs beiträgt.

- Lehnenbreite/-höhe: 51/48 cm
- 1-teilige Ausführung
- schnelle und einfache Montage
- maschinenwaschbar bei 30°C



Sitzkissen

- 80197 Sitzkissen**
und Gummibefestigung
Bezug Kunstleder schwarz
Länge: 370 mm
Breite: 520 mm
Höhe: 300 mm
passend zu Steyr Plus



- 60976 Sitzpolster schwarz**
Länge: 380 mm
Breite: 450 mm
Höhe: 290 mm
passend zu Klepp Elastomat



Kraftstofffilter

- 02042 Kraftstofffilter**
verwendbar anstelle von WK-842.1
WK-842.2 1013 1012 KC17 KC18
161500080043 3132428R2 J931062
01174482 87800220



- 97125 MANN-Kraftstofffilter**
verwendbar anstelle von WK842/2



- 51840 Kraftstofffilter**
verwendbar anstelle von BFU707

€
~~7,99~~
6,60



- 08251 Kraftstofffilter**
verwendbar anstelle von P707 1024 KX35 457
PF834 S7411N 2660900

€
~~4,99~~
4,10

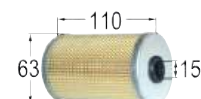

- 77366 Kraftstofffilter**
verwendbar anstelle von P725X

€
~~10,40~~
8,70

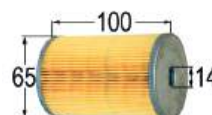

Ölfilter

- 08250 Ölfilter**
verwendbar anstelle von W-940
2030 OC59 339 B7156
S3241R 2324100

€
~~6,99~~
5,80



- 92465 MANN-Ölfilter**
verwendbar anstelle von W-940
2030 OC59 339 B7156
S3241R 2324100

€
~~9,99~~
8,30



- 51838 Ölfilter**
verwendbar anstelle von W-962

€
~~10,99~~
9,10



- 51841 Hydraulik-Ölfilter**
verwendbar anstelle von W951/5 OC70

€
~~22,99~~
19,10



- 53200 Ölfilter**
verwendbar anstelle von W1140/11

€
~~16,30~~
13,60

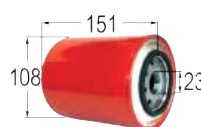

- 53201 Ölfilter**
verwendbar anstelle von W930

€
~~8,99~~
7,40

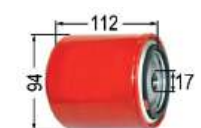

- 53245 Ölfilter**
verwendbar anstelle von H615 PT9131 2553500

€
~~20,99~~
17,40

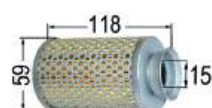

- 40428 Ölfilter**
verwendbar anstelle von H1038X 2049
OX15 481 PT12 S4380PO 2545500
1883288M91

€
~~5,60~~
4,70



Luftfilter

Nr. Bezeichnung €
 51846 Luftfilter 32,70
 verwendbar anstelle von CF-600 **27,30**



51847 Luftfilter 30,50
 verwendbar anstelle von CF-700 **25,40**



51849 Luftfilter 21,40
 verwendbar anstelle von C-13114.4 **17,80**



Luftfiltereinsätze

Nr. Bezeichnung €
 54333 Luftfiltereinsatz 25,90
 passend zu Plus 40, 540, 545, 548, 50, 650, 658, 60, 768, 8045 **21,60**
 verwendbar anstelle von 209190705



93684 Profiling für Ölbadfilter 13,90
 passend zu Steyr Plus **11,60**
 verwendbar anstelle von 140619704

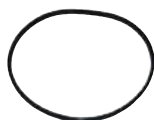

53706 Luftschlauch 10,90
 L = 600 mm 9,10
 ID = 60 mm
 passend zu Steyr Plus
 verwendbar anstelle von 3081908
 1308001900



54245 Luftfilter kpl. 34,50
 passend zu Steyr Plus **28,80**



53707 Staubbehälter 7,20
 passend zu Steyr Plus **6,00**
 verwendbar anstelle von 307190702



60785 Dichtring zu Staubbehälter 8,50
 passend zu Steyr **7,10**
 verwendbar anstelle von 1209190029



97975 Federclip 7,90
 verwendbar anstelle von 280190712 **6,60**
 passend zu Steyr



Nr. Bezeichnung €
 72031 Luftfiltereinsatz 30,90
 verwendbar anstelle von 140800190002 **25,80**



72027 Luftfiltereinsatz 40,90
 verwendbar anstelle von 1406190032 **34,10**



72030 Luftfiltereinsatz 40,90
 verwendbar anstelle von 1406190033 **34,10**



Hydraulikfilter

Nr. Bezeichnung €
 71697 Hydraulikfilter 22,90
 verwendbar anstelle von HY10072, 02311975, 2311975, HX14, HY10072, SH52772 **19,10**



71695 Hydraulikfilter 38,90
 verwendbar anstelle von HY9397 **32,40**



71696 Hydraulikfilter 56,90
 verwendbar anstelle von HY9421 **47,40**



Filtergehäuse

Nr. Bezeichnung €
 54330 Doppelfiltergehäuse 34,90
 passend zu Serie Plus **29,10**
 verwendbar anstelle von 407 08 0122



54331 Einfachfiltergehäuse 20,90
 passend zu Serie Plus **17,40**
 verwendbar anstelle von 307 08 730



54332 Filtergehäuse 49,90
 passend zu Serie Plus **16,60**
 verwendbar anstelle von 307 08 728



Einfachfilter

Nr. Bezeichnung €
 63326 Einfachfilter 54,90
 verwendbar anstelle von: **43,30**
 131100080083
 passend zu 942, 948 8000, 8045, 8055, 8060, 8065, 8070, 8075, 8080, 8085, 8090, 8100, 8110, 8130



Kabinenfilter

Nr.	Bezeichnung	€
72040	Kabinenfilter verwendbar anstelle von 134184042	32,90 27,40



Lenkungsfilter

Nr.	Bezeichnung	€
69834	Lenkungsfilter verwendbar anstelle von P105-HD P106-HD	9,90 8,30

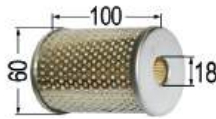

Druckluftbremse

Nr.	Bezeichnung	€
52985	Kupplungskopf rot mit Ventil IG M16x1,5	10,90 9,10



52986	Kupplungskopf gelb mit Ventil IG M16x1,5	10,90 9,10
-------	---	---------------------------------



52987	Kupplungskopf rot mit Ventil IG M22x1,5	10,90 9,10
-------	--	---------------------------------



52988	Kupplungskopf gelb mit Ventil IG M22x1,5	10,90 9,10
-------	---	---------------------------------



Oberlenker



Nr.	Bezeichnung	L	G	L1	d	h	€
92315	Oberlenker Kat. II zu Steyr 35700740035	560/770	M28 x 3	410	25,6	43,8	79,90 66,60

92393	Oberlenkerhaltefeder						6,90 5,80
-------	----------------------	--	--	--	--	--	--------------------------------



Stabilisator

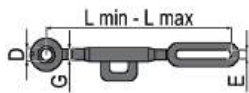

Nr.	Bezeichnung	L	D	E	€
52866	Stabilisator kpl. zu 80-Serie, Plus Serie	475/580	29	22	48,90 40,80

52867	Stabilisator kpl. zu Steyr Plus-Serie	530/660	29	22	58,90 49,10
-------	--	---------	----	----	----------------------------------

60924	Stabilisator kpl. zu Steyr Serie 80				77,90 64,90
-------	--	--	--	--	----------------------------------



62775	Stabilisator verwendbar anstelle von: 47133794 passen zu Serie CVT: 6130, 6145, 6160				145,90 121,60
-------	--	--	--	--	------------------------------------



Nr.	Bezeichnung	€
63152	Seitenstrebe B = 50 mm, S = 10 mm, Loch-Ø = 28 mm passend zu Steyr T80, T84, T180	38,90 32,40



64819	Stabilisator verwendbar anstelle von: 84578110, 133700740315, 133700740280, 133700740216 passend zu 955, 964, 970, 9078, 9086, 9094 M: 948, 952, 958, 963, 9080, 9083, 9090 MT: 9080, 9085, 9090, 9100, 9105	199,00 165,80
-------	---	------------------------------------



Hubstrebenenteile

Nr.	Bezeichnung	€
97989	Anhängvorrichtung vorne verwendbar anstelle von 06000930001	101,90 84,90



53697	Anhängvorrichtung drehbar für Anhängbolzen Ø 32 mm verwendbar anstelle von 295930002	119,90 99,90
-------	--	-----------------------------------



80672	Hubstrebe verstellbar Gabel 28 mm, L min 525 mm passend zu Serie 80	239,90 199,90
-------	---	------------------------------------



80673	Hubstrebe verstellbar Gabel 42 mm, L min 530 mm passend zu Serie 80, 900	214,90 178,90
-------	--	------------------------------------



92429	Hubstrebe Gabel = 42 mm L = 600 - 680 mm passend zu Serie 80	224,90 186,90
-------	---	------------------------------------



90692	Gabel zu Hubstrebe 80673 42 mm	71,90 59,90
-------	-----------------------------------	----------------------------------



90693	Gabel zu Hubstrebe 48 mm	71,90 59,90
-------	-----------------------------	----------------------------------



53696	Hubstrebe Länge 420-540 mm, Loch oben 18 mm, unten 25 mm passend zu Plus Serie verwendbar anstelle von 29574501	119,90 99,90
-------	---	-----------------------------------



60800	Kurbel passend zu Steyr verwendbar anstelle von 288740050	15,30 12,80
-------	---	----------------------------------



60801	Ring verwendbar anstelle von 1288740179	5,70 4,80
-------	--	--------------------------------



60798	Kegelradwelle passend zu Steyr verwendbar anstelle von 292740151	44,00 36,70
-------	--	----------------------------------



60799	Spindel verwendbar anstelle von 190740057	45,30 37,80
-------	--	----------------------------------



Nr. **Bezeichnung** **€**
77876 Gelenk **28,90**
 verwendbar anstelle von **24,10**
 292740078



77877 Bolzen **15,90**
 verwendbar anstelle von **13,30**
 292740148



62606 Bolzen **9,50**
 L = 90 mm, Ø = 18 mm **7,90**
passend zu 8045,8070,8075
Plus Serie: 540,545,548,
650,658,760,768
 verwendbar anstelle von 1292740142



54356 Hubstrebe **74,90**
passend zu Plus Serie **62,40**
 verwendbar anstelle von
 295740502



56619 Unterlenker **189,90**
passend zu Plus Serie **157,50**
 verwendbar anstelle von 0500074001



54242 Befestigung für Seitenstrebe **45,90**
13,30



Kupplung

Nr. **Bezeichnung** **L** **G** **€**
50020 Kupplungs-Muffe **38,90**
 69,5 mm **32,40** AG M30 x 1,5
 IG M22 x 1,5
 Schott passend zu Serie 80
 Überwurfmutter M38x1,5



Hydraulikpumpen

Nr. **Bezeichnung** **€**
50188 Hydraulikpumpe re. **169,90**
 16,5 l/min bei 1500 1/min **140,80**
verwendbar anstelle von:
 Bosch 510420005/ 510325006/
 HYZFR116R1/ HYZFR18CR101
passend zu T188, Plus 30
 bis M-Nr.: 3260,
 Lenkung Plus 870, 980, 988,
 1090, 1100, 1108, 1200



50189 Hydraulikpumpe li. **174,80**
 21 l/min bei 1500 1/min **145,70**
verwendbar anstelle von:
 Bosch 510520309/ 510525335/
 HYZFR111CL101
passend zu Plus 540, 545, 548, 548a,
 190 am M-Nr.: 7522



50190 Hydraulikpumpe li. **198,90**
 24 l/min bei 1500 1/min **165,80**
verwendbar anstelle von:
 Bosch 510620304/ 510625337
passend zu Plus 50, 1100, 650
 bis M-Nr.: 15236,
 760 bis M-Nr.: 3834, 870,
 bis M-Nr.: 3830, 980 alt,
 1090 bis M-Nr.: 1560, T288- T290



Nr. **Bezeichnung** **€**
50191 Hydraulikpumpe li. **476,90**
 16,5 l/min bei 1500 1/min **147,40**
verwendbar anstelle von:
 Bosch 510510315/ 510515311
passend zu Plus760, 8055,
 8055A, 8060



50192 Hydraulikpumpe li. **489,90**
 24 l/min bei 1500 1/min **157,50**
verwendbar anstelle von:
 Bosch 510610315/ 510610321/
 510615302/ 510615315
passend zu 870 ab M-Nr.: 4284, 980,
 988,1090 abM-Nr.: 2036,1100 ab M-Nr.:
 1284, 1200, 1400, 8055, 8060, 8070,
 8075, 8080, 8090, 8100, 8110, 8120,
 8130, Lenkung 8140, 8150, 8160, 8170



50193 Hydraulikpumpe li. **484,90**
 16,5 l/min bei 1500 1/min **154,10**
verwendbar anstelle von:
 Bosch 510515310
passend zu 8100, 8110, 8120, 8130,
 Lenkung 8055, 8060, 8070, 8075,
 8080, 8090, 8100 bis M-Nr.: 2521,
 8120 bis M-Nr.: 2519



50194 Hydraulikpumpe li. **469,40**
 12 l/min bei 1500 1/min **141,20**
verwendbar anstelle von:
 Bosch 510415313/ 510410316/
 HYZFR18CL104/ HYZFS18L204
passend zu 8080, 8090, 8130, 8075



50195 Hydraulikpumpe li. **488,90**
 28,5 l/min bei 1500 1/min **157,40**
verwendbar anstelle von:
 Bosch 510615321/ 510615337
passend zu 8080, 8090, 8130
 mit Zusatzhubzylinder



50196 Hydraulikpumpe li. **389,90**
 24 u. 16,5 l/min bei 1500 1/min **324,20**
verwendbar anstelle von:
 Bosch 510660311/ 510665322/
 HYZFR2168CL102
passend zu Plus 650 bis M-Nr.:
 15237, 760 bis M-Nr.: 3834



50197 Hydraulikpumpe li. **399,90**
 24 u. 16,5 l/min bei 1500 1/min **332,50**
verwendbar anstelle von:
 510660320/ 510665331/
 HYZFR1168CL141
passend zu Plus 650
 ab M-Nr.: 15238, 760 bis ab.: 3835



50198 Hydraulikpumpe li. **424,90**
 24 u. 16,5 l/min bei 1500 1/min **354,10**
verwendbar anstelle von:
 Bosch 510665335/ 510665367/
 510665382/ 510665393
passend zu 955, 964, 970,
 9078, 9086, 9094 mit MWM-Motor



60602 Hydraulikpumpe **799,90**
verwendbar anstelle von: **665,80**
 0510765393, 87600468
passend zu 9080, 9085,
 9090, 9095, 90100,
 9105MT



55345 Hydraulikpumpe 32 u. 16 l/min. **1299,90**
verwendbar anstelle von: **1082,50**
 1-32-575-003/ 510768023
passend zu 9105, 9115, 9125, 9145



Nr. Bezeichnung €
 55315 Hydraulikpumpe 22,5+16 ~~428,90~~
 verwendbar anstelle von: **357,40**
 1-32-975-101/ 510765351
 passend zu 9078, 9086, 9094
 m. Sisu Motor



55310 Lenkungspumpe ~~89,00~~
 passend zu 768 **74,20**



55321 Hydraulikpumpe ~~489,00~~
 verwendbar anstelle von: **157,50**
 0510515316
 passend zu 975/M975



94453 Mitnehmer ~~42,90~~
 zu HD-Pumpe **10,80**



Zusatzsteuergeräte

Nr. Bezeichnung €
 50199 Zusatzsteuergerät zu System SB7 ~~386,90~~
 einfachwirkend und doppelwirkend **349,00**
 verwendbar mit Schwimmstellung



94564 Dichtsatz kpl. ~~23,90~~
 passend zu Zusatzsteuergerät SB7 **19,90**
 (50199)

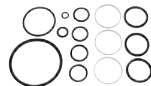

50200 Univ. Hebelsatz ~~442,90~~
 passend zu Serie 80 **94,90**

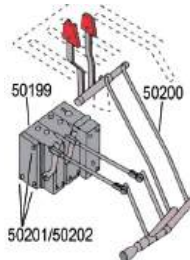

50201 Schraubensatz ~~46,90~~
 2. Pos. 3x M8x190 10.9 2x M6x120 **14,10**

50202 Schraubensatz ~~35,90~~
 3. Pos. 3x M8x240 10.9 2x M6x170 **29,90**

50205 Zusatzsteuergerät zu System SB23 ~~478,90~~
 re. und li. **429,00**
 einfachwirkend und
 doppelwirkend verwendbar
 mit Schwimmstellung
 passend zu Serie 900, 9000



51580 Zusatzsteuergerät ~~599,00~~
 zu System SB23 LS load sensing **539,00**
 doppelwirkend verwendbar
 mit Schwimmstellung gerastet
 vergleichbar Bosch 521610000,
 521610003, 521610005, 521610007,
 521510008, 521510011, 521610012,
 521610017
 passend zu Serie 9000



63605 Endsteuergerät zu SB7 ~~268,90~~
 verwendbar anstelle von: **224,10**
 HYSRZ10C1, 0521706005,
 288730230, 1397730152
 passend zu 30, 60, 70, 90, 430, 540,
 545, 548, 650, 658, 760, 768, 870, 980,
 988, 1090, 1108, 1100, 1200, 1208,
 1400, 8095, RS1 & RS2: 8045, 8055,
 8065, 8075, 8085, SK1 & SK2: 8055,
 8060, 8070, 8080, 8090, 8100, 8110,
 8120, 8130, T: 188, 190, 288, 290



Ventile

Nr. Bezeichnung €
 50214 Regelventil SRZ ~~699,00~~
 dient zur Regelung des Hubwerkes **629,00**



62857 Dichtsatz zu Hauptsteuergerät 50214 ~~68,90~~
57,40



80099 Steuerventil 12 250 70 ~~969,00~~
 SB23 Volt Bar l/min **869,00**

Dieses Zusatzsteuergerät ist ein
 5/3-Wegeventil, das zur Steuerung von
 Zylindern und Hydromotoren elektrisch
 betätigt wird.

- doppel- und einfachwirkend
 mit Schwimmstellung
- äußerst hohe innere Dichtigkeit
- beidseitig verwendbar
- inkl Dichtplatte u.

Magnetstecker
 passend zu Serie
 M9000, M9078,
 M9078 A,
 M9086 A,
 M9094 A

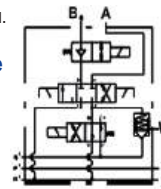

Hydrolenkungssatz

Nr. Bezeichnung €
 54734 Hydrolenkungssatz ~~864,90~~
 kpl. mit Ölpumpe und Gelenke **589,00**
 nicht geprüft und nicht typisiert
 passend zu Plus 768



51369 Hydrolenkungssatz ~~899,00~~
 mit Doppelpumpe **749,20**
 kpl. mit Ölpumpe und Gelenke
 nicht geprüft und nicht typisiert
 passend zu Plus 50,
 650, 658, 60, 760, 768



51550 Lenkgeber zu 54734 und 51369 ~~388,90~~
324,10



51551 Bolzen zu 51550 ~~48,90~~
40,80



96582 Dichtsatz für Lenkzylinder ~~40,90~~
 passend zu Lenkungssätze **34,10**



Lenkservostate

Nr. Bezeichnung €
 61309 Lenkservostat OSPC 160 OR **748,90**
 passend zu Profi Serie: 4100, 4110, **624,10**
 4115, 6115, 6125, 6135, 6140
 verwendbar anstelle von
 84266845, 87391518



61692 Lenkservostat Modell ZF 85 ccm **699,00**
 passend zu Plusserie: 545a, 548a, **582,50**
 658a, 760a, 768a Serie: 80-8060 SK1,
 8070 SK1, 8080 SK1 bis FIN.: 8946
 verwendbar anstelle von 1192 470123,
 1192 470134, 1192 470138,
 1192 470139, 1192 470780



61693 Lenkservostat Modell ZF 120 ccm **749,00**
 passend zu Steyr **599,20**
 verwendbar anstelle von
 137700470072, 8452955302,
 137700470123, 37700470072



63712 Lenkservostat **429,00**
 verwendbar anstelle von: **357,50**
 47801470, 84266842, 5196526
 passend zu Kompakt: 360, 370, 375,
 485, 495, 4065, 4075, 4085, 4095



63713 Lenkservostat **489,00**
 verwendbar anstelle von: **407,50**
 245690010, 245690250
 passend zu Serien: Argon, Commando,
 Dorado, Dorado F, Dorado S, Dorado V,
 Frutteto, Frutteto Tier 4i, Golden, Solaris,
 Solaris Tier 3, Tiger, Tiger Tier 3



Leuchten

Nr. Bezeichnung €
 51712 Blink-Positionsleuchte re./li. **14,90**
 Ø = 80 mm **12,40**
 passende Lampe:
 1 x 00441, 1 x 51737



51713 Ersatzglas re./li. **7,90**
 Blink-Positionsleuchte **6,60**
 Ø = 80 mm



51714 Schluss-Brems-Blinkleuchte **13,90**
 Ø = 80 mm **11,60**
 „nicht STVO geprüft“
 passende Lampe: 1 x 00440, 1 x 51737



51716 Ersatzglas Schluss-Brems-Blinkleuchte **9,40**
 Ø = 80 mm **7,80**



51702 Blink-Positionsleuchte re./li. **28,90**
 passende Lampe: **24,10**
 1 x 00441, 1 x 00440

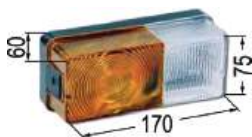

51703 Ersatzglas re./li. **19,90**
 zu Blink-Positionsleuchte **16,60**



Nr. Bezeichnung €
 51704 Schluss-Brems-Blinkleuchte re. **28,90**
 51705 Schluss-Brems-Blinkleuchte li. **28,90**
 mit Kennzeichenbeleuchtung **24,10**
 passende Lampe: 2 x 00441, 1 x 00397



51706 Ersatzglas re. zu Rücklicht **19,90**
16,60



51707 Ersatzglas li. mit Kennzeichenbel. **19,90**
16,60

97420 Ersatzglas li. mit Kennzeichenbel. **19,90**
16,60

53931 Blink-Positionsleuchte re. **63,90**
53,30



53932 Blink-Positionsleuchte li. **63,90**
 passende Lampe: 1 x 51737, 1 x 00441 **53,30**



53933 Ersatzglas re./li. **12,90**
10,80

61718 Blink-Positionsleuchte re. **16,90**
14,10



61719 Blink-Positionsleuchte li. **16,90**
14,10

53820 Schluss-Brems-Blinkleuchte re. **15,90**
13,30

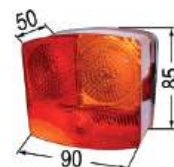

53821 Schluss-Brems-Blinkleuchte li. **15,90**
 mit Kennzeichenbeleuchtung, **13,30**
 Glas dreigeteilt
 passende Lampe: 2 x 00441, 1 x 00397

53822 Ersatzglas re. 90 x 85 **15,90**
13,30



53823 Ersatzglas li. 90 x 85 **15,90**
 mit Kennzeichenbeleuchtung **13,30**

53986 Schluss-Brems-Blinkleuchte re. **23,90**
19,90



53987 Schluss-Brems-Blinkleuchte li. **23,90**
 mit Kennzeichenbel., Glas dreigeteilt **19,90**
 mit Schraube
 passende Lampe: 2 x 00441, 1 x 00397

53988 Ersatzglas re. **15,90**
13,30



53989 Ersatzglas li. **18,90**
 mit Kennzeichenbeleuchtung **15,80**

53994 Schluss-Brems-Blinkleuchte re. **15,90**
13,30



53995 Schluss-Brems-Blinkleuchte li. **15,90**
 mit Kennzeichenbeleuchtung **13,30**
 passende Lampe: 2 x 00441, 1 x 00397

53996 Ersatzglas re. **11,90**
9,90



53997 Ersatzglas li. **11,90**
 mit Kennzeichenbeleuchtung **9,90**

Nr.	Bezeichnung	€		Nr.	Bezeichnung	€	
09869	Blink-Positionsleuchte re./li. passende Lampe: 1 x 00441, 1 x 51737	12,90 10,80		53042	Blink-Positionsleuchte rechts verwendbar anstelle von: 87313173	68,90 57,40	
09859	Ersatzglas re./li. zu Blink-Positionsleuchte	6,10 5,10		53043	Blink-Positionsleuchte links verwendbar anstelle von: 87313174 passend zu 6115 CVT, 6125 CVT, 6135 CVT, 6140 CVT, 9080 MT, 9085 MT, 9090 MT, 9095 MT, 9100 MT, 9105 MT, Profi 4100, 4110, 4115, 4120, 6115, 6125, 6140, Profi Ecotech 4110, 4120, 4130, 6125, 6140, Profi Tier III 4100, 4110, 4115, 4120, 6125, 6140, 9000 passende Lampen: 1 x 00397, 1 x 80128	68,90 57,40	
51717	Schluss-Brems-Blinkleuchte re. hellrot	23,90 19,90		64514	Rückleuchte re. verwendbar anstelle von: 87304535, 82037618, 87747246	69,90 57,50	
63294	Schluss-Brems-Blinkleuchte re.RAL3003 nicht geprüft passend zu Steyr Plus passende Lampe: 1 x 00441, 1 x 00440	26,90 22,40		64515	Rückleuchte li. verwendbar anstelle von: 87747247, 82037619 passend zu Kompakt: 4055S, 4065S, 4075, 4085, 4095, 4105, 4115 Terrus: 6270 CVT, 6300 CVT	69,90 57,50	
51718	Schluss-Brems-Blinkleuchte li. hellrot	23,90 19,90		64516	Ersatzglas re. verwendbar anstelle von: 87304535, 87747246, 82037618	49,90 16,60	
63295	Schluss-Brems-Blinkleuchte li. RAL3003 mit Kennzeichenbeleuchtung, nicht geprüft passend zu Steyr Plus passende Lampe: 1 x 00441, 1 x 00440	26,90 22,40		64517	Ersatzglas li. verwendbar anstelle von: 87304536	49,90 16,60	
51719	Blink-Positionsleuchte re. hellrot	23,90 19,90		90926	Rückleuchte re. verwendbar anstelle von: 87536434	84,90 70,80	
63296	Blink-Positionsleuchte re. RAL3003 nicht geprüft passend zu Steyr Plus passende Lampe: 1 x 00441, 1 x 00397	26,90 22,40		90927	Rückleuchte li. verwendbar anstelle von: 87536435 passend zu 6115 CVT, 6125 CVT, 6135 CVT, 6140 CVT, 6165 CVT, 6180 CVT, 6200 CVT, 6210 CVT, 6225 CVT, 4100 Profi, 4110 Profi, 4115 Profi, 4120 Profi, 4130Profi, 6115Profi, 6125Profi, 6140Profi	84,90 70,80	
51720	Blink-Positionsleuchte li. hellrot	23,90 19,90		51167	Rückleuchte li. verwendbar anstelle von: 134676002	61,90 51,60	
63297	Blink-Positionsleuchte li. RAL3003 nicht geprüft passend zu Steyr Plus passende Lampe: 1 x 00441, 1 x 00397	26,90 22,40		51168	Rückleuchte re. verwendbar anstelle von: 134676001 passend zu Steyr 9105, 9155, 9125, 9145, M 9078, 9078A, 9083A, 9086A, 9094A, CVT 120, 130, 150, 170 passende Lampe: 2 x 00441, 1 x 00397	61,90 51,60	
53585	Ersatzglas rot-orange rechts	4,50 3,80		51155	Schluss Blinkleuchte Ø 80 passende Lampe: 1 x 51737, 1 x 51739	24,90 20,80	
53586	Ersatzglas rot-orange links	4,50 3,80		51169	Schluss Blinkleuchte mit Kennzeichenb. passende Lampe: 1 x 51737, 1 x 51739	25,90 21,60	
53581	Ersatzglas weiß-orange rechts	4,50 3,80		51159	Blink-Positionsleuchte passende Lampe: 1 x 51737, 1 x 51739	24,90 20,80	
53582	Ersatzglas weiß-orange links	4,50 3,80		51174	Rückleuchte Ø 60 passende Lampe: 1 x 51737	16,90 14,90	
53583	Ersatzglas gelb hinten rechts, vorne links	4,10 3,40		74893	Schlussleuchte rot-orange passende Lampe: 1 x 00440 1 x 51737	33,90 28,30	
53584	Ersatzglas gelb hinten links, vorne rechts	3,90 3,30		74822	Schlussleuchte rot-orange mit Kennzeichenleuchte passende Lampe: 1 x 00440 1 x 51737	33,90 28,30	
53587	Ersatzglas weiß links seitlich	4,10 3,40		74894	Schlussleuchte rot mit Kennzeichenleuchte, zu T80/84/86 und vielen alten Traktoren passende Lampe: 1 x 00440 1 x 51737	33,90 28,30	
60804	Rückstrahler zu Rückleuchte Plus Länge = 62 mm, Breite = 39 mm verwendbar anstelle von: 93760705	3,90 3,30					

Oldtimer Lampen rund im Systembausatz

Nr.	Bezeichnung	€
96703	Ersatzglas rot	9,90 8,30
96704	Ersatzglas rot/orange	10,90 9,10
96705	Gehäuse rund passende Lampe: 1 x 00440 1 x 51737	24,70 20,60
96706	Gehäuse rund mit Kennzeichenleuchte passende Lampe: 1 x 00440 1 x 51737	26,90 22,40
96701	Rahmen Chrom mit Schrauben	12,90 10,80
96702	Rahmen schwarz mit Schrauben	11,90 9,90
97158	Dichtgummi passend zu Systemleuchte rund	2,60 2,20
74812	Gummiplatte für Lampe 65 x 55 mm	8,50 7,10
92411	Gummi für Lampe 95 x 42 mm	4,90 4,10
92412	Gummi für Lampe 62 x 42 mm	6,90 5,80
96011	Lichtscheibe zu Blinker passend zu Steyr T86	20,90 17,40



Oldtimer Lampen oval im Systembausatz

Nr.	Bezeichnung	€
96326	Lichtscheibe weiß zu Systemlampe	8,90 7,40
94859	Lichtscheibe rot zu Systemlampe	8,90 7,40
94858	Lichtscheibe weiß/orange zu Systemlampe	8,90 7,40
94857	Lichtscheibe rot/orange zu Systemlampe	8,90 7,40
94856	Gehäuse für Schluss-Brems oder Begrenzungsleuchte zu Systemleuchte passende Lampe: 1 x 51737, 1 x 51740	22,90 19,10



Nr.	Bezeichnung	€
94597	Gehäuse für Schluss-Bremsleuchte mit Kennzeichenbeleuchtung zu Systemleuchte passende Lampe: 1 x 51737, 1 x 51740	22,90 19,10
94598	Systemleuchte-Gehäuse 2 Kammern passende Lampe: 1 x 51737, 1 x 51740	23,90 19,90
96327	Systemleuchte-Rahmen mit Nase, mit Dichtung und Schrauben	10,90 9,10
96328	Systemleuchte-Rahmen mit Dichtung und Schrauben	9,90 8,30
96340	Systemleuchte Chrom-Rahmen mit Dichtung und Schrauben	9,90 8,30
96341	Ersatzdichtung zu Systemleuchte	2,90 2,40

Hauptscheinwerfer

Nr.	Bezeichnung	€
02850	Scheinwerfer rund Ø 160 mm mit Gewinderohrbefestigung M16 passende Lampe: 1 x 00295, 1 x 00451	28,90 23,90
51148	Fassung für Standlicht Kunststoff 2 Anschlüsse	2,30 1,90
60816	Scheinwerfereinsatz 105 mm	24,90 20,80
53574	Scheinwerfer kpl. rund 110 mm aus Metall mit Standlicht für alte Traktoren passende Lampe: 1 x 00439, 1 x 00451	33,30 39,90
80551	Reflektor 110 mm	33,90 28,30
80553	Streuscheibe 110 mm	25,90 21,60
80554	Dichtgummi zu 80553	12,90 10,80
96010	Adapter zu Scheinwerfer	16,90 14,10
80552	Fassung für 80551	16,90 14,10
77865	Scheinwerfer rechts 130 mm	49,90 41,60
77866	Scheinwerfer links 130 mm passende Lampe: 1 x 00295, 1 x 51742 mit Rohrbefestigung 24 mm	49,90 41,60
96010	Adapter zu Scheinwerfer	16,90 14,10



Nr.	Bezeichnung	€		Nr.	Bezeichnung	€	
51148	Fassung für Standlicht Kunststoff 2 Anschlüsse	2,30 1,90		64893	LED Arbeitsscheinwerfer verwendbar anstelle von: 87539115, AL209455 passend zu: CVT: 6170, 6185, 6205, 6215, 6230	54,90 45,80	
51143	Fassung für Standlicht Metall 1 Anschluss	2,20 1,80		64744	Arbeitsscheinwerfer verwendbar anstelle von: 4271840M92, G931901115010 passend zu CVT: 6130, 6155, 6186, 6195, 6230, 6240 M: 9080, 9100	69,00 57,50	
61388	LED Fassung für Standlicht	3,90 3,30		61614	LED Arbeitsscheinwerfer Rund 12-36 Volt, 25 Watt, 1860 Lumen	413,90 94,90	
42014	Stecksockel für Lampe 3-polig	3,20 2,70		51699	Scheinwerfer mit Befestigung M10 Einbau: rechts und links passend zu Steyr Serie Plus passende Lampe: 1 x 00439	49,90 42,90	
93918	Stecksockel-Adapter	6,80 5,70		27238	Hauptscheinwerfer H4 182 x 105 x 102 mit Standlicht passende Lampe: 1 x 00373, 1 x 00451	45,90 38,30	
53794	Hauptscheinwerfer H3 re./li. verwendbar anstelle von: 134672400, 47106801 passend zu Steyr 9105,9115,9125, 9145,9150,CVT120,130,150,170 passende Lampe: 1 x 00299	82,90 69,10		36549	Hauptscheinwerfer re./li. ohne Standlicht passend zu Steyr Serie 80 passende Lampe: 1 x 00295	34,90 29,10	
52903	Scheinwerfereinsatz mit Begrenzungslicht passend zu Steyr 8055,8075 Serie: 900-9000; passende Lampe: 1 x 00373	36,90 30,80		36550	Hauptscheinwerfer H4 re./li. passend zu Steyr Serie 80 passende Lampe: 1 x 00373	36,90 30,80	
35907	Einbauscheinwerfer kpl. re./li. L=165 H=105 LA=130, Hella 1AB996025-047 passend zu Steyr 9105-9145 CVT CVX passende Lampe: 1 x 00373, 1 x 00451	36,90 30,80		51147	Hauptscheinwerfer H4 182 x 102 mm passend zu Steyr 9000, CVT passende Lampe: 1 x 00373	34,90 26,60	
90925	Arbeitsscheinwerfer 182 x 101 x 80 mm verwendbar anstelle von: 1-40-172-011 passend zu Steyr 080 M, 9090 M, 9100 M, 9080 MT, 9085 MT, 9090 MT, 9095 MT, 9100 MT, 9105 MT, M 9078, M 9083, 9078, 9086, 9094, 9105, 9115, 9125, 9145 passende Lampe: 2 x 00299	87,90 73,30		53038	Scheinwerfer re. verwendbar anstelle von: 47056003 338,90 299,00		
98303	LED Arbeitsscheinwerfer 3280 Lumen Licht: 30 x 2W LEDs, Spannung: 10 - 30V B = 182,5 mm H = 102 mm T = 61 mm Rauschunterdrückung: Ja Betriebstemperatur: -45°C bis +55°C IP: IP69 Kabellänge: 1000 mm Stromverbrauch 12V: 1.91 A, 24V: 0.95 A verwendbar anstelle von: 00123610, 00123610, 0000123610, G312900113000, G312900113010, G312900113020, 1GB996080011, 70042300, 70040400, 3713137M1 passend zu Steyr 942, 948, 955, 964, 970, 8080, 9078, 9086, 9090, 9094	48,90 41,90		53039	Scheinwerfer li. verwendbar anstelle von: 47056056 passend zu Steyr 6135,6145, 6155,6170,6190CVT, Profi 4100,4110,4115,4120,4130, 9080, 9085, 9090, 9095 Kompakt 360,370,375,485,495 passende Lampe: 1 x 00373, 1 x 53934	338,90 299,00	
64894	LED Arbeitsscheinwerfer verwendbar anstelle von: 47056003 passend zu Steyr CVT: 6130, 6140, 6145, 6150, 6160, 6165, 6175, 6180, 6195, 6200, 6210, 6225 Kompakt: 360, 370, 375, 485, 495, 4055S, 4065, 4065S, 4075, 4085, 4095, 4105, 4115 MT: 9080, 9085, 9090, 9095, 9100, 9105 Multi: 4095, 4105, 4115 Profi: 4100, 4110, 4115, 4120, 4130, 6115, 6125, 6135, 6140 Profi CVT: 4110, 4120, 4130	62,90 52,40					

Steckdosen

Nr.	Bezeichnung	€
06501	Steckdose 7-polig Metall	4,30 3,60

89693	Steckdose 7-polig Metall mit Flachsteckanschluss	44,90 9,90
-------	--	----------------------

04491	Dichtung zu Steckdose	0,90 0,80
-------	-----------------------	---------------------

95195	Dichtung zu Steckdose seitlich gerade	4,90 0,80
-------	---------------------------------------	---------------------

19036	Steckdose 3-polig 4 - Loch, mit Verschlussdeckel	8,20 6,80
-------	---	---------------------

26957	Steckdose 3-polig 2 - Loch, mit Verschlussdeckel	7,90 6,60
-------	---	---------------------

Rückstrahler

Nr.	Bezeichnung	€
00410	Rückstrahler $\varnothing = 80$ mm rot mit Befestigungsschraube M5	4,90 1,50

06113	Rückstrahler rot 98 x 62 mit Befestigungsschraube M6	4,40 3,70
-------	--	---------------------

LED-Arbeitscheinwerfer 27 Watt

Arbeitscheinwerfer - breiter Strahl

Technische Daten

Licht-Ausgang: 1620 Lumen
Eingangsspannung: 10-30 V DC
Stromverbrauch: 1,8 A bei 12 V DC, 22 W - 0,9 A bei 24 V DC, 22 W

Schutzart: IP68
Wechselbare Polarität: geschützt
Leds: 9 Leds 3 W, hohe Intensität

Arbeitstemperatur: bis 60°C
Halterung: Neigungsverstellbarer Klemmbügel

Material: Aluminiumgehäuse, Glas PMMA
Gewicht: 600 g

Nr.	Bezeichnung	€
80527	LED-Scheinwerfer 106 x 132	49,50 16,30

98280	LED-Scheinwerfer CE R23 (Rückfahrcheinwerfer)	29,90 24,90
-------	---	-----------------------

LED-Arbeitscheinwerfer 18 Watt

Arbeitscheinwerfer - 60° breiter Strahl

Technische Daten

Licht-Ausgang: 1080 Lumen
Eingangsspannung: 9-32 V DC
Stromverbrauch: 1,3 A bei 12 V DC, 18 W - 0,6 A bei 24 V DC, 18 W

Schutzart: IP67
Wechselbare Polarität: geschützt

Leds: 6 Led 3 Watt
hohe Intensität
Material: Aluminiumgehäuse
Glas PMMA

Nr.	Bezeichnung	€
83530	LED-Scheinwerfer 110 x 60 mm	24,90 18,30

LED-Arbeitscheinwerfer 24 Watt

Arbeitscheinwerfer

Technische Daten

Licht-Ausgang: 1200 Lumen
Eingangsspannung: 10-32 V DC
Stromverbrauch: 1,5 A bei 12 V DC 0,75 A bei 24 V DC

Wechselpolung: Umpolungssicher
Leds: 8 LED 3 Watt
Arbeitstemperatur: -40°C bis +80°C

LED-Arbeitscheinwerfer 15 Watt

Arbeitscheinwerfer - breiter Strahl

Technische Daten

Licht-Ausgang: 1150 Lumen
Eingangsspannung: 10-30 V DC
Stromverbrauch: 1 A bei 12V DC, 12 W - 0,55 A bei 24V DC, 13,2 W

Schutzart: IP67
Wechselbare Polarität: geschützt
Leds: 5 Leds 3 W, hohe Intensität

Arbeitstemperatur: bis 60°C
Halterung: Neigungsverstellbarer Klemmbügel

Material: Aluminiumgehäuse, Glas Polycarbonat
Gewicht: 600 g

Nr.	Bezeichnung	€
80526	LED-Scheinwerfer 100 x 100	16,90 14,10

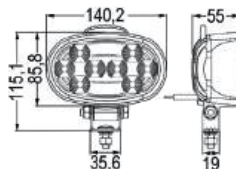
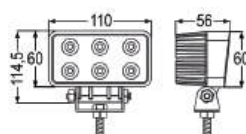
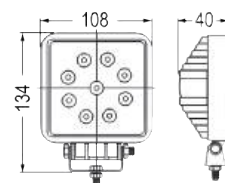
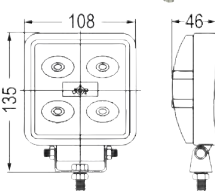

Nr.	Bezeichnung	€
90712	LED-Scheinwerfer 140 x 85,8 mm	58,90 49,10

LED-Scheinwerfer 24 Watt

Arbeitscheinwerfer

Technische Daten

Licht-Ausgang: 1400 Lumen
 Eingangsspannung: 10-32 V DC
 Farbtemperatur: 6000 K
 Stromverbrauch: 1,5 A bei 12 V DC
 0,75 A bei 24 V DC
 Schutzart: IP67
 Wechselpolung: Umpolungssicher
 Leds: 8 LED 3 Watt, hohe Intensität
 Material: Aluminiumgehäuse, Glas PC

Nr. Bezeichnung
 97886 LED-Scheinwerfer
 Oval 140 x 85,8

€
~~25,90~~
19,90



LED-Scheinwerfer 45 Watt

Arbeitscheinwerfer

Technische Daten

Licht-Ausgang: 4500 Lumen
 Eingangsspannung: 10-30 V DC
 Farbtemperatur: 6000 K
 Schutzart: IP68
 Leds: 15 LED 3 Watt, hohe Intensität
 Halterung: Neigungsverstellbarer Klemmbügel
 Material: Aluminiumgehäuse, PMMA

CE/UKCA/RoHS/R10

Nr. Bezeichnung
 62852 LED-Scheinwerfer

€
~~35,90~~
28,90



LED-Arbeitscheinwerfer 48 Watt

Arbeitscheinwerfer - breiter Strahl 60°

Technische Daten

Licht-Ausgang: 2880 Lumen
 Eingangsspannung: 9-32 V DC
 Stromverbrauch: 3,8 A bei 12 V DC, 48 W -
 1,9 A bei 24 V DC, 48 W
 Schutzart: IP67

Wechselbare

Polarität: geschützt
 Leds: 16 Leds 3 W, hohe Intensität
 ca. 60° Leuchtwinkel

Arbeitstemperatur: bis 60°C
 Halterung: Neigungsverstellbarer Klemmbügel

Material: Aluminiumgehäuse, Glas PMMA

Gewicht: 930 g

Nr. Bezeichnung
 83531 LED-Scheinwerfer 110 x 110 mm

€
~~27,90~~
23,30



Schalter

Nr.	Bezeichnung	€
51694	Bremslichtschalter	7,00 5,80



53792	Bremslichtschalter passend zu Steyr Serie 80 (COBO 15.105.000)	19,90 16,60
-------	--	----------------------------------



63750	Kontaktschalter-Handbremse verwendbar anstelle von: 87735366, 5195039 passend zu Kompakt: 360, 370, 375, 485, 495	28,90 24,10
-------	---	----------------------------------



09863	Druckschalter Bremslicht, Zapfwelle, Startsperr verwendbar anstelle von: 5163618, 82026949, 47132449	20,90 17,40
-------	---	----------------------------------



92462	Schalter Differential/Allrad Bremspedal verwendbar anstelle von: 141571805, 47107500 passend zu Steyr 9105, 9115, 9125, 9145, 6135 CVT, 6140 CVT, 6145 CVT, 6150 CVT, 6155 CVT, 6160 CVT, 6170 CVT, 6190 CVT, 6195 CVT, 9080 M, 9090 M, 9100 M, CVT 120, CVT 130, CVT 150, CVT 170, M 9078, M 9086, M 9094	134,90 112,40
-------	---	------------------------------------



90929	Bremslichtschalter für Handbremse verwendbar anstelle von: 84142375, 82015210, 87364942 passend zu Steyr Profi 4100, 4115, 4110, 6115, 6125, 6135, 6140, CVT 6165, 6180, 6200, 6210, 6225	33,90 28,30
-------	---	----------------------------------



90931	Drehwinkelsensor (Lage) EHR, Brems- und Kupplungsbetätigung verwendbar anstelle von: 87605245, 82021035, 87543715, 87559698, 82017877 passend zu Steyr Kompakt 360, 370, 375, 4065, 4075, 4085, 4095, 485, 495, Profi 4100, 4110, 4115, 4120, 4130, 6115, 6125, 6135, 6140, CVT 6165, 6180, 6200, 6210, 6225	98,90 82,40
-------	--	----------------------------------



90932	Bremslichtschalter für Fußbremse verwendbar anstelle von: 5190018	35,60 29,70
-------	---	----------------------------------



90973	Bremslichtschalter verwendbar anstelle von: 140271104, 140271004	28,90 24,10
-------	--	----------------------------------



passend zu Steyr 9078, M 9078, 9080 M,
 M 9083, 9086, M 9086, 9090 M, 9094,
 M 9094, 9100 M, 9105, 9115, 9125, 9145

Nr.	Bezeichnung	€
05523	Stopschalter mit Gewinde Länge 25 mm	8,80 7,30
05590	Stopschalter mit Gewinde Länge 40 mm	8,80 7,30
00083	Anlassknopf Einbauöffnung Ø = 24,5 mm	6,90 5,80
74820	Hupenschalter passend zu Steyr T80/84/86	17,90 14,90
12621	Zugschalter 3-Anschlüsse mit Beleuchtung, Einbauöffnung Ø = 12,5 mm	44,90 12,40
94386	Schalter Lastschaltung H-L verwendbar anstelle von: 1397580085 passend zu Steyr 9078, 9086, 9094, M: 9078, 9083, 9086, 9094;	55,90 46,60
90978	Druckschalter Zapfwelle-Ein Außenschaltung Kotflügel verwendbar anstelle von: 140258046	48,90 15,80
90979	Druckschalter Zapfwelle-Aus Außenschaltung Kotflügel verwendbar anstelle von: 140258064 passend zu Steyr 9078, 9086, 9094, 9105, 9115, 9125, 9145, M 9078, M 9083, M 9086, M 9094	48,90 15,80
90944	Druckschalter Heben und Senken verwendbar anstelle von: 1964848C1, 701/23200, 7700011831, 139900580042 passend zu Steyr - diverse Typen	49,90 16,60
90980	Druckschalter Heben-Senken verwendbar anstelle von: 3388402M91, 3388402M1, 139900580042 passend zu Steyr diverse Typen	49,90 16,60
90981	Druckschalter Hubwerk senken verwendbar anstelle von: 140258062, 3714138M1	49,90 16,60
90982	Druckschalter Hubwerk heben verwendbar anstelle von: 140258061, 3714137M1 passend zu Steyr 9078, 9086, 9094, 9105, 9115, 9125, 9145, M 948, M 952, M 958, M 963, M 968, M 975, M 9078, M 9083, M 9086, M 9094;	49,90 16,60
90983	Druckschalter Warnblinkanlage verwendbar anstelle von: 133700580081	48,90 15,80



Nr.	Bezeichnung	€
90984	Druckschalter Drehleuchte 12 V / 20 A verwendbar anstelle von: 133700580006	20,90 17,40
90985	Druckschalter Hauptscheinwerfer 12 V / 1,2 W verwendbar anstelle von: 133700580004, 701/07800	20,90 17,90
90986	Druckschalter Arbeitsscheinwerfer 12 V / 20 A vorne, oben verwendbar anstelle von: 133700580007	20,90 17,90
90987	Druckschalter Arbeitsscheinwerfer 12 V / 20 A hinten verwendbar anstelle von: 133700580008, 139900580153	20,90 17,40
90988	Druckschalter Wischanlage verwendbar anstelle von: 133700580003, 01177149, 01177161, 01177150	49,90 16,60
90989	Druckschalter Wisch-Intervall verwendbar anstelle von: 133700580005	49,90 16,60
90990	Druckschalter Gebläse verwendbar anstelle von: 133700580005	49,90 16,60
90991	Druckschalter Gebläse verwendbar anstelle von: 133700580121	49,90 16,60
90992	Druckschalter Taster- Lastschaltkupplung langsam verwendbar anstelle von: 133700580011	21,90 18,30
90993	Druckschalter Taster- Lastschaltkupplung schnell verwendbar anstelle von: 133700580010	49,90 16,60
90994	Druckschalter Warnblinkanlage verwendbar anstelle von: 01177148, 133700580002	20,90 17,40



Nr.	Bezeichnung	€		Nr.	Bezeichnung	€	
90995	Druckschalter Allrad verwendbar anstelle von: 3552862M91, 133700580109, 133700580102	20,90 17,40		91003	Druckschalter Zylinder-Ein Regelhydraulik Fronthubwerk verwendbar anstelle von: 140558063, 47111664	20,90 17,40	
90945	Taster Heckzapfwelle hinten am Kotflügel verwendbar anstelle von: 82025543 passend zu Steyr Profi 4100, 4110, 4115, 4120, 4130, 6115, 6125, 6135, 6140, CVT 6165, 6180, 6200, 6210, 6225	22,90 19,10		91004	Druckschalter Zylinder-Aus Regelhydraulik/Fronthubwerk verwendbar anstelle von: 140558062, 47111665 passend zu Steyr CVT 6135, 6140, 6145, 6150, 6155, 6160, 6170, 6175, 6190, 6195	20,90 17,40	
90946	Taster Heckzapfwelle PTO Ein-Aus Drucktaster Außenschaltung Kotflügel verwendbar anstelle von: 140558045, 47111209 140558044, 47111206 passend zu Steyr CVT 6135, 6140, 6145, 6150, 6155, 6160, 6170, 6175, 6190, 6195, M 9080, 9090, 9100, MT 9080, 9085, 9090, 9100, 9105	20,90 17,40		90942	Drehknopf Gebläse 4 Stufen verwendbar anstelle von: 82023545, 87538397 passend zu Steyr Profi 4100, 4110, 4115, 4120, 4130, 6115, 6125, 6135, 6140, CVT 6165, 6180, 6200, 6210, 6225	71,90 59,90	
90996	Druckschalter Zapfwelle-Aus Außenschaltung Kotflügel verwendbar anstelle von: 140258078, 140558037 passend zu Steyr 9105, 9115, 9125, 9145, M 9078, M 9086, M 9094	23,90 19,90		90939	Zapfwellenschalter verwendbar anstelle von: 87311254, 82028271 passend zu Steyr Profi 4100, 4110, 4115, 4120, 4130, 6115, 6125, 6135, 6140	101,30 84,40	
90997	Druckschalter Zapfwelle-Ein verwendbar anstelle von: 140258077, 140558036 passend zu Steyr 9105, 9115, 9125, 9145, M 9078, M 9086, M 9094	22,90 19,10		90953	Front-Zapfwellenschalter verwendbar anstelle von: 87605071, 87311258 passend zu Steyr Profi 4100, 4110, 4115, 4120, 4130, 6115, 6125, 6135, 6140	96,90 80,00	
90998	Druckschalter Regelhydraulik heben verwendbar anstelle von: 140258075	23,90 19,90		90954	Schalter-Hubwerk verwendbar anstelle von: 5173877 passend zu Steyr Kompakt 360, 370, 375, 4065, 4075, 4085, 4095, 485, 495	28,90 24,10	
90999	Druckschalter Regelhydraulik senken Außenschaltung Kotflügel verwendbar anstelle von: 140258076 passend zu Steyr 9105, 9115, 9125, 9145, 9080M, 9090M, 9100M, M 948, 952, 958, 963, 968, 975, 9078, 9086, 9094, CVT 120, 130, 150, 170	23,90 19,90		90955	Schutzkappe-Schalter-Hubwerk verwendbar anstelle von: 5169266 passend zu Steyr Kompakt 360, 370, 375, 4065, 4075, 4085, 4095, 485, 495	10,20 8,50	
91000	Druckschalter Regelhydraulik heben verwendbar anstelle von: 140558046, 47111210	20,90 17,40		61151	Start-Schalter verwendbar anstelle von: 87561528, FP560 F0NN11N501AA, 81864288, 65441, 82025888, passend zu Steyr Serien: CVT, Profi;	66,90 55,80	
91001	Druckschalter Regelhydraulik senken Außenschaltung Kotflügel verwendbar anstelle von: 140558045, 47111210 passend zu Steyr 6135 CVT, 6140 CVT, 6145 CVT, 6150 CVT, 6155 CVT, 6160 CVT, 6170 CVT, 6175 CVT, 6190 CVT, 6195 CVT, 9080 M, 9090 M, 9100 M, 9080 MT, 9085 MT, 9090 MT, 9100 MT, 9105 MT	20,90 17,40		63752	Startschalter E11 6,3 x 0,8 Anlasswiederholsperr: Ja Vorglühfunktion: Nein Anzahl Stecker: 3 verwendbar anstelle von: 276590340, 84255016004, 05755065, 1589236, 20500306	46,90 39,10	
91002	Druckschalter Hubwerk heben verwendbar anstelle von: 47057241, 140558048 passend zu Steyr Kompakt: 370, 375, 4075, 4085, 4095, 485, 495, Profi: 4100, 4115, 6115, 6125, 6135, CVT: 6135, 6140, 6145, 6150, 6155, 6160, 6170, 6175, 6190, 6195, 9080M, 9090M, 9100M	20,90 17,40		95991	Bosch Start-Schalter mit 4 Steckanschlüsse 15, 17, 19, 50a verwendbar anstelle von: 0343008009	56,90 47,40	
				95992	Zugknopf zu Bosch Start-Schalter 95991 verwendbar anstelle von: 3343231070	5,10 4,30	

Nr.	Bezeichnung	€	
53704	Start-Schalter 4 Anschlüsse mit Vorglühlung und Steckverbinder 15, 17, 19, 50a	20,90 17,40	
95993	Bosch Start-Schalter mit 4 Schraubanschlüssen 15, 17, 19, 50a	60,90 50,80	
95992	Zugknopf zu Bosch Start-Schalter 95993 verwendbar anstelle von: 3343231070	5,40 4,30	
54749	Start-Schalter 4 Anschlüsse mit Vorglühlung und Schraubanschlüsse 15, 17, 19, 50a	24,90 20,80	
53705	Zündschloss Einbauöffnung 26 mm 15, 30, 56a, 56b, 58 passend zu Serie Plus	25,90 21,60	
53689	Zündschloss Einbauöffnung 26 mm passend zu Steyr T80/T84, 15,30,56,56A,56B,58	43,90 36,60	
95995	Bosch Zündschloss mit Steckanschlüssen 15, 30, 56a, 56b, 58 verwendbar anstelle von: 0342201010	57,90 48,30	
53903	Startschalter Bosch Einbauöffnung 21,5 mm 17, 19, 30, 50a, 15/54, 58 verwendbar anstelle von: 0342316003	48,90 40,80	
53904	Startschalter Bosch Einbauöffnung 21,5 mm 15, 17, 19, 30, 50a verwendbar anstelle von: 0342315001	54,90 45,80	
53680	Ersatzschlüssel	6,90 5,80	
53553	Schlüssel zu Bosch groß	4,90 4,10	
57685	Universal Glühanlass-Schalter Einbauöffnung 26,5 mm mit Flachsteckanschlüsse passend zu Steyr 942, 948, 952, 955, 958, 963, 964, 968, 970, 975, 8080, 8090, M: 948, 952, 958, 963, 968, 975, 9078, 9083, 9086, 9094;	49,90 41,90	

	0	I	II
58—30			
15/54-30			
19—30			

Nr.	Bezeichnung	€	
96279	Glühanlass-Schalter mit 6 Flachsteckanschlüsse verwendbar anstelle von: 140258008, 87312354 passend zu Steyr CVT: 120, 130, 150, 170, CVT: 6135, 6140, 6145, 6150, 6155, 6160, 6170, 6175, 6190, 6195, M: 9078, 9086, 9094, 9078, 9086, 9094, 9105, 9115, 9125, 9145, -M: 9080, 9090, 9100, MT: 9085, 9095, 9100, 9105,	67,90 56,60	
62749	Ersatzschlüssel zu 96275, 96276, 96277, 96278, 96279, 57685	8,90 7,40	
90976	Sensor Fahrgeschwindigkeit verwendbar anstelle von: 87564762 passend zu Steyr Profi 4100, 4110, 4115, 4120, 4130, 6115, 6125, 6135, 6140, CVT 6165, 6180, 6200, 6210, 6225	94,90 79,10	
90975	Schalter Getriebezustand low verwendbar anstelle von: 87369250, 82020682, 82018879 passend zu Steyr Profi 4100, 4110, 4115,4120, 4130, 6115, 6125, 6135, 6140;	71,90 59,90	
91006	Sensor Steuerwinkel-Vorderachse verwendbar anstelle von: 82019691 passend zu Steyr Profi 4100, 4115, 6115, 6125, 6135	288,90 240,80	
91024	Magnetventil 132 mm PWM Ventil verwendbar anstelle von: 87739558 passend zu Steyr Profi 4110, 4120, 4130, 6115, 6125, 6140, CVT 6165, 6180, 6200, 6210, 6225	225,90 188,30	
91021	Sensor Zapfwellendrehzahl verwendbar anstelle von: 87564776 passend zu Steyr Profi 4100, 4115, 6115, 6125, 6135	46,90 39,10	
91022	Sensor Zapfwellendrehzahl verwendbar anstelle von: 87564763 passend zu Steyr Profi 4110, 4120, 4130, 6115, 6125, 6140, CVT 6195, 6210	54,90 45,80	
91023	Sensor Drehzahl-Getriebe Hall Effect verwendbar anstelle von: 84169162 passend zu Steyr Profi 4100, 4110, 4115, 4120, 4130, 6115, 6125, 6140, CVT 6165, 6180, 6200, 6210, 6225	99,90 83,30	

Nr. **Bezeichnung** **€**
90934 Druckschalter **48,90**
 Lenkung, Powershuttle,
 Allrad, Differentialsperre
verwendbar anstelle von:
 87395493, 5115055, 82031395
passend zu Steyr Kompakt
 360, 370, 375, 4065, 4075, 4085, 4095,
 485, 495, Profi 4100, 4110, 4115, 4120,
 4130, 6115, 6125, 6135, 6140, CVT 6165,
 6180, 6200, 6210, 6225



90937 Potentiometer-Getriebe **58,90**
verwendbar anstelle von: **49,10**
 87605247, 82033385, 87559692,
 82021036, 82010303
passend zu Steyr Kompakt 4065,
 4075, 4085, 4095, Profi 4110, 4115,
 4120, 4130, 6115, 6125, 6135, 6140



90938 Potentiometer Synchronisierung **154,90**
verwendbar anstelle von: **129,10** 87685207
passend zu Steyr CVT 6165, 6180,
 6200, 6210, 6225



90974 Sicherheitsschalter **32,90**
verwendbar anstelle von: **27,40**
 140171051, 140171001
passend zu Steyr 9080 M, 9090 M,
 9100 M, M 948, M 952, M 958, M 963,
 M 968, M 975, M 9078, M 9083,
 M 9086, M 9094, 942, 948,
 955, 964, 970, 9078, 9086, 9094



94387 Sicherheitsschalter-Start **69,90**
verwendbar anstelle von: **58,30** 1397710005
passend zu Steyr Serie 80



61296 Lenkstockschalter **158,90**
verwendbar anstelle von: **132,40** 82035488
passend zu Steyr
 Profi Classic Tier 3
 ab 06/09 bis 12/11:
 4110, 6125, 6140



53702 Blinkerschalter Ø 44 mm
 mit Hupe und Auf- Abblendlichtschalter
passend zu Steyr Serie Plus



54789 Blinkerschalter Ø 38 mm
passend zu Steyr
 Serie 80



94384 Schalter Neutralstellung **329,90**
verwendbar anstelle von: **274,20**
 140771023, 47110458
passend zu Steyr 9105, 9115, 9125, 9145,
 CVT: 120, 130, 150, 170, 6135, 6140, 6145,
 6150, 6155, 6160, 6170, 6175, 6190, 6195



80677 Lenkstockschalter **188,90**
passend zu Steyr **157,40**
 Serie 9000



Nr. **Bezeichnung** **€**
90928 Multifunktionsschalter **198,90**
 Horn, Licht und Blinker
verwendbar anstelle von: 87733123,
 87302770, 87623195, 87756692,
 87544517, 87602310
passend zu Steyr Profi 4100,
 4110, 4115, 4120, 4130,
 6115, 6125, 6135, 6140,
 CVT 6165, 6180, 6200,
 6210, 6225



53593 Blinkerschalter **25,90**
 Einbauöffnung 25 mm
passend zu Steyr T80, 84, 86,
 185, 188, 190, 288, 290 **21,60**



Traktormeter

Nr. **Bezeichnung** **€**
53698 Traktormeter **44,90**
verwendbar anstelle von: 3375867 **37,40**
passend zu Steyr 188, 190,
 288, 290, 40, 540, 545,
 548, 50, 650, 658, 60, 760, 768



96009 Dichtgummi zu Traktormeter **42,90**
passend zu Steyr Plus **10,80**



53765 Traktormeter **39,90**
verwendbar anstelle von: 13570058008 **33,30**
passend zu Steyr 8045, 8055,
 8060, 8065, 8070, 8075,
 8080, 8090



53699 Traktormeterwelle **19,50**
 L = 1700 mm, Gewinde 2 x M18x1,5 **16,30**
verwendbar anst. von: 133700580001
passend zu Steyr 188, 190, 288, 290, 40,
 540, 545, 548, 50, 650, 658, 60, 760, 768



53766 Traktormeterwelle **17,70**
 L = 1540 mm, Gewinde 2x M18x1,5 **14,80**
verwendbar anstelle von: 0477580001
passend zu Steyr



54200 Traktormeterwelle **21,90**
 L = 1720 mm, **18,30**
 Gewinde M18 x 1,5 / M22 x 1,5
verwendbar anstelle von: 337700580202
passend zu Steyr 8070, 8080, 8090



86745 Traktormeterwelle **23,90**
 L = 2000, 2 x M18x1,5 **19,90**
passend zu Steyr



86744 Traktormeterwelle **53,90**
 L = 2110, M18/M22x1,5 **44,90**
passend zu Steyr



53700 Winkeltrieb **28,90**
verwendbar anstelle von: 925816 **24,10**
passend zu Steyr



53701 Kuppler **4,50**
verwendbar anstelle von: 1925836 **3,80**
passend zu Steyr Serie Plus



54201 Kuppler 131100010191 **10,50**
passend zu Steyr Serie 80 **8,80**



Hupen

Nr.	Bezeichnung	€
00437	Hupe 12 V	6,50 5,40



01354	Horn 12 V	8,90 6,90
-------	-----------	---------------------



Relais

Nr.	Bezeichnung	€
00707	Blinkerrelais 12 V, 21/99 Watt 3 Anschlüsse	8,90 7,40



00708	Blinkerrelais 12 V 4 x 21 / 8 x 21 W	16,90 12,90
-------	---	-----------------------



90966	Blinkerrelais verwendbar anstelle von: 87577636, 82022809, 87373529, 82038684, 82023525, 47127173, 5095785 passend zu Steyr Kompakt 4065, 4075, 4085, 4095, 360, 370, 375, 485, 495, Profi 4100, 4110, 4115, 4120, 4130, 6115, 6125, 6135, 6140, CVT 6165, 6180, 6200, 6210, 6225	178,90 149,10
-------	--	-------------------------



02101	Einschaltrelais 12V 20/30A	4,90 4,10
-------	-------------------------------	---------------------



90968	Vorglührelais verwendbar anstelle von: 86619908, 82022813 passend zu Steyr Kompakt 4065, 4075, 4085, 4095, 485, 495, Profi 4100, 4110, 4115, 4120, 4130, 6115, 6125, 6135, 6140, CVT 6165, 6180, 6200, 6210, 6225	239,00 199,20
-------	--	-------------------------



90969	Relais Scheibenwischerintervall verwendbar anstelle von: 140258090, 140258060 passend zu Steyr 6135 CVT, 6140 CVT, 6145 CVT, 6150 CVT, 6155 CVT, 6160 CVT, 6170 CVT, 6175 CVT, 6190 CVT, 6195 CVT, 9080 M, 9090 M, 9100 M, 9080 MT, 9085 MT, 9090 MT, 9100 MT, 9105 MT, CVT 120, CVT 130, CVT150, CVT170, M968, M975, M9078, M9086, M9094, 9105, 9115, 9125, 9145	74,90 62,40
-------	---	-----------------------



90970	Zeitrelais 40 sec. verwendbar anstelle von: 140758104, 140258001, 140258160 passend zu Steyr 9078, 9086, 9094, 9105, 9115, 9125, 9145, 6135 CVT, 6145 CVT, 6155 CVT, 6170 CVT, 6190 CVT, 6195 CVT, 9080 M, 9090 M, 9100 M, CVT 120, 130, 150, 170, M 9078, 9083, 9086, 9094	218,90 182,40
-------	---	-------------------------



Nr.	Bezeichnung	€
74891	Einschaltrelais für Arbeitsstrom 12V-40/15A	36,90 30,80

passend zu Steyr 955,964,970,948M,
958M,968M,975M, 9078,9080,9086,
9090,9094,9100,9105,9115,9125,9145,
9078M,9083M,9086M,9094M,C55,64,70,
CS100,110,120,130,150,48,58,68,78,86,
94,CVT120,130,150,170,6135,6145,
6155,6170,6190,CVX1135,1145,1155



74892	Micro-Relais 12V - 15/25A passend zu Steyr 948M,952M,958M, 963M,968M,975M,9078M,9080M,9086M, 9090M,9094M,9100M,9105M,9115M, 9125M,9145M,CS48,52,58,63,68,75,78, 86,94,CVT120,130,150,170,6135,6145, 6155,6170,6190,CVX120,130,150,170	4,40 3,70
-------	---	---------------------



Bilux Lampen

zu Hauptscheinwerfer

Nr.	Bezeichnung	Volt	Watt	Socket	€
00295	Glühlampe	12 V	45/40W		2,50 2,10



Halogenlampen

zu Drehleuchte, Haupt-, Nebelscheinwerfer

Nr.	Bezeichnung	Volt	Watt	Socket	€
08048	Lampe H1	12 V	55W	P14,5s	2,20 1,80



zu Arbeits-, Fern- u. Abblendscheinwerfern

Nr.	Bezeichnung	Volt	Watt	Socket	€
00299	Lampe H3	12 V	55W	PK22s	1,90 1,60



zu Hauptscheinwerfer

Nr.	Bezeichnung	Volt	Watt	Socket	€
00373	Lampe H4	12 V	60/55W	P43t	3,20 2,70



Lampen zu Schluss- Bremsleuchten

Nr.	Bezeichnung	Volt	Watt	€
00439	Glühlampe zu Hauptscheinwerfer	12 V	45/40 W	2,50 2,10



00397	Kugellampe nicht geprüft	12 V	5 W	0,70 0,60
-------	-----------------------------	------	-----	---------------------



00441	Kugellampe nicht geprüft	12 V	21 W	0,60 0,50
-------	-----------------------------	------	------	---------------------



00440	Zweifaden- Kugellampe nicht geprüft	12 V	21/5 W	0,60 0,50
-------	---	------	--------	---------------------



51737	Soffitte L = 36 mm nicht geprüft, zu Pos., -Schluss- u. Kennzeichenleuchten	12 V	5 W	0,90 0,80
-------	--	------	-----	---------------------



51738	Soffitte L = 36 mm nicht geprüft	12 V	10 W	1,30 1,10
-------	-------------------------------------	------	------	---------------------



00277	Soffitte L = 40 mm nicht geprüft, zu Pos., -Schluss- u. Kennzeichenleuchten	12 V	5 W	0,50 0,40
-------	--	------	-----	---------------------



Lampensätze

Nr.	Bezeichnung	€
53942	Lampensatz 12V H7/H1	12,90 10,80



Sicherungen

Nr.	Bezeichnung	€
00263	Sicherungssortiment 200 Stk. Flachstecksicherungen 7,5A 50 Stk. 10A 50 Stk. 15A 50 Stk. 25A 50 Stk. 400 Stk. Basketit-Sicherungseinsätze 8A 150 Stk. 15A 150 Stk. 40A 100 Stk.	52,60 43,80



87888	Basketit-Sicherungssortiment 200 Stk.	46,90 14,10
-------	--	-----------------------



97078	Basketit Sicherungssortiment 10 Stk.	4,50 1,30
-------	---	---------------------



Sicherungsdosen

54305	Sicherungsdose 8 Sicherungen passend zu Steyr Serie Plus	17,90 14,90
-------	---	-----------------------



93973	Sicherungsdose 10 Sicherungen passend zu Steyr	48,90 15,80
-------	---	-----------------------



64566	Sicherungsdose wie Original 10-Sicherungen passend zu Steyr 8045, 8065 RS2, 8075 RS2	57,00 47,50
-------	---	-----------------------



64565	Sicherungsdose wie Original 10-Sicherungen passend zu Steyr 8055, 8060 SK1, 8070 SK1, 8065 RS1, 8075 RS1, 8080 SK1, 8090 SK1, 8100 SK1, 8120 SK1	57,00 47,50
-------	--	-----------------------



64567	Sicherungsdose wie Original 10-Sicherungen passend zu Steyr 8060 SK2, 8070 SK2, 8080 SK2, 8090 SK2, 8100 SK2, 8130 SK2	57,00 47,50
-------	---	-----------------------



Starter

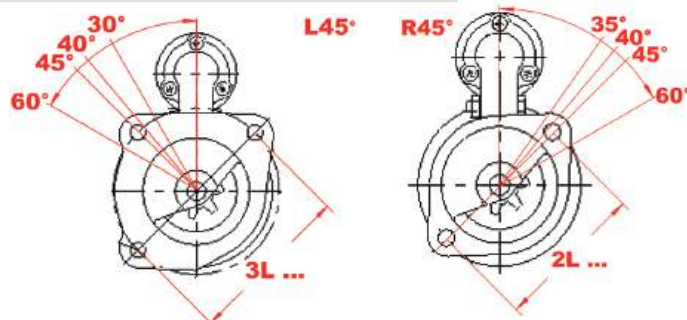

Nr.	Bezeichnung	Volt	KW	Zähne	€
26490	Starter Winkel L60° Löcher 3L, 146	12	2,7	9	249,00 207,50



43032	Starter Winkel R45° Löcher 3L 127	12	2,8	10	245,90 204,90
-------	---	----	-----	----	-------------------------



51728	Starter Winkel R35° Löcher 2L 105	12	2,7	9	228,90 190,80
-------	---	----	-----	---	-------------------------



51732	Starter Winkel R35° Löcher 2L 105	12	3	11	258,90 224,90
-------	---	----	---	----	-------------------------



51733	Starter Winkel R35° Löcher 2L 105	12	3	9	259,00 215,80
-------	---	----	---	---	-------------------------



53283	Starter Winkel L40° Löcher 3L 127	12	3	11	259,00 215,80
-------	---	----	---	----	-------------------------



53284	Starter Winkel R35° Löcher 2L 105	12	2,7	9	254,00 209,20
-------	---	----	-----	---	-------------------------



53285	Starter Winkel R35° Löcher 2L 105	12	3	9	248,90 207,40
-------	---	----	---	---	-------------------------



53286	Starter Winkel L40° Löcher 3L 127	12	3	9	249,00 207,50
-------	---	----	---	---	-------------------------



53288	Starter Winkel R45° Löcher 3L 127	12	3	11	246,90 205,80
-------	---	----	---	----	-------------------------



Starter

Nr.	Bezeichnung	Volt	KW	Zähne	€
55367	Starter Winkel R45° Löcher 3L 146	12	2,8	10	229,00 190,80
55370	Starter Winkel R30° Löcher 3L 127	12	2,7	9	214,90 179,10
55386	Starter Winkel R45° Löcher 3L 127	12	3	10	269,00 224,20
55391	Starter z. Steyr T180 Winkel R45° Löcher 2L 105	12	2,7	9	249,00 207,50
55393	Starter Winkel R30° Löcher 3L 127	12	4,2	11	289,00 240,80
78315	Starter Winkel L45° Löcher 2L 105	12	2,7	11	389,00 324,20
78770	Starter Winkel L45° Löcher 3L 146	12	2,6	9	263,90 219,90
78771	Starter Winkel L45° Löcher 3L 127	12	4,2	10	279,00 232,50
64885	Starter Winkel 45° Löcher 3L 146	12	2,7	10	288,90 240,80



passend zu Marke /Type

51728	Steyr 80,84,86,188,190,+30,+40,430,540,545,548
55391	Steyr 180,182,185,280
51732	Steyr 288,290,+50,650,658,760,768
53283	Steyr 70+,90+,870,980,1090,1100,1200
78315	Steyr 942,948,8045
53286	Steyr 988,1108,1400A,8140,8150,8160,8165,8170,8180
51733	Steyr 8055,8060,8065,8070,8075,8080,8085,8090,8095
53284	Steyr 8055,8060,8065
53285	Steyr 8100,8110,8120,8130
55370	Steyr 955,964,970,M968,M975,9078,9086,9094,M9078, M9083,M9086,M9094 2,7 kw
55367	Steyr M948,M958,M952,M963
64885	Steyr M948, WD303
53288	Steyr M968,M975,9094 Valmet/Sisu Motor
55386	Steyr M968,M975,M9078,M9086,M9094,9105,9115, 9125,9145,CVT120,CVX120,CVT130,CVX130,CVT150, CVX150,CVT6145,CVT6135,CVT6155,CVT6170,667,680 Valmet/Sisu Motor
43032	Steyr 9155,9160,9170,9180,9190,9200
55393	Steyr CVT120,CVX120,CVT130,CVX130,CVT150,CVX150, CVT170,CVX170,CVT6145,CVT6135,CVT6155,CVT6170
26490	Steyr 360,370,375 2,7 kW
78770	Steyr 360,370,375 2,6 kW
78771	Steyr 485,495,4085,4095

Lichtmaschinen

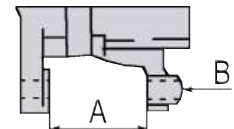
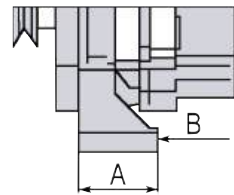

Nr.	Bezeichnung	Volt	Ampere	€
10786	Lichtmaschine mit Riemenscheibe einfach Ø 90 mm x 9,7 mm A = 70 mm, B = 12,0 mm	14 V	45 A	164,90 137,40
51721	Lichtmaschine mit Riemenscheibe einfach Ø 68 mm x 9,7 mm A = 56 mm, B = 8,2 mm	14 V	33/45 A	124,90 99,90
51727	Lichtmaschine mit Riemenscheibe einfach Ø 73 x 9,7 mm, A = 56,0 mm, B = 8,2 mm	14 V	65A	414,90 95,80
53124	Lichtmaschine passend zu Case	14 V	95A	149,90 124,90
53290	Lichtmaschine A = 73 mm, B = 10,0 mm, mit Riemenscheibe einfach, Ø 82 x 9,7mm	14 V	34A	414,90 95,80
53291	Lichtmaschine mit Riemenscheibe einfach, Ø 68 x 9,7mm, A = 56 mm, B = 8,2 mm	14 V	80A	469,90 141,60
53294	Lichtmaschine ohne Riemenscheibe A = 51 mm B = 10,0 mm	14 V	65A	452,90 127,40
53295	Lichtmaschine ohne Riemenscheibe A = 51 mm B = 10 mm	14 V	95A	214,90 179,10
69913	Lichtmaschine mit Riemenscheibe einfach Ø 68 x 9,7 mm, A = 56 mm B = 8,2 mm	14V	33A	419,00 99,20
78132	Lichtmaschine mit Riemenscheibe einfach Ø 73 x 9,7 mm, A = 56,0 mm B = 8,2 mm	14V	65A	416,90 96,90
91942	Lichtmaschine ohne Riemenscheibe A = 56, B = 8,2	14V	45A	129,70 108,10
94807	Lichtmaschine ohne Riemenscheibe, A = 50,8 mm, B = 10 mm zu Laverda, Steyr	14V	120A	492,90 160,80



Lichtmaschinen

Nr.	Bezeichnung	Volt	Ampere	€
94808	Lichtmaschine ohne Riemenscheibe, B = 8,5 mm, A = 56 mm,	14V	120A	472,90 144,10
94809	Lichtmaschine mit Riemenscheibe 10R, Ø 65,3 mm, Winkel L60°, B = 10,1 mm, A = 56,5 mm	14V	150A	285,90 238,30
94810	Lichtmaschine mit Riemenscheibe 10R, Ø 65,6 mm, Winkel L60°, B = 10 mm, A = 56,6 mm	14V	200A	299,00 249,20
94811	Lichtmaschine mit Riemenscheibe 8R, Ø 59,6 mm, Winkel R60°, B = 10 mm, A = 83 mm	14V	120A	150,90 125,80
94812	Lichtmaschine ohne Riemenscheibe, Winkel L/R60° A = 56 mm, B = 8 mm	14V	120A	458,90 132,40
94813	Lichtmaschine mit Riemenscheibe 8R, Ø 65,5 mm, Winkel R60°, A = 83 mm, B = 8 mm zu CNH-Steyr	14V	120A	498,90 165,80



Nr. passend zu Marke /Type

80504	Steyr alte Modelle T80/84.....
53290	Steyr Serie Plus bei Umbau von Gleichstromlichtmaschine
51721/	Steyr
91942	540,545,548,650,658,760,768,980,988,1100,1108,1200,8055,8060,8065,8070,8075,8080,8090,8100,8110,8120,8130,8140,8150,8160,8170
10786	Steyr 8045
51727/	Steyr
78132	980,988,1100,1108,1200,8055,8060,8065,8070,8075,8080,8090,8100,8110,8120,8130,8140,8150,8160,8165,8170
53291	Steyr 968M,975M,9078M,9086M,9094M
41154	Steyr 948,958
51727/	Steyr 950,955,960,964,970
78132	
53291	Steyr 950,960,970
53294	Steyr 9105,9115,9125,9145 CVT,CVX
53295	Steyr 9105,9115,9125,9145 CVT,CVX
53124	Steyr 968,975,9080,9090,9094,9100,CVT120,130,150,170,6135,6145,6155,6170,6190
94807	Steyr CVT: 120,130
94808	Steyr CVT:150,170,6135,6145,6155,6170,6190, -MT:9080,9085,9090,9095,9100,9105
94809	Steyr CVT: 6130, 6145
94810	Steyr CVT: 6170, 6185, 6205, 6215, 6230
94811	Steyr Kompakt: 360, 370, 375, 485, 495, 4065, 4075, 4085, 4095
94812	Steyr 9094, 9125, 9145, M: 9083, 9094,

Zahnkränze

Nr.	Bezeichnung	€
54381	Zahnkranz 130 Zähne, Ø 357 mm verwendbar anstelle von: 6100002021 passend zu 4 Zylinder 50,60,70,90,760,870,980,8070,8075,8080	90,20 75,20
54387	Zahnkranz 122 Zähne, Ø 329 mm passend zu 3 Zylinder T188,190,30,40,430,540,545,548	75,90 63,30
91934	Zahnkranz 128 Zähne, Ø = 360 mm (mit SISU Motor) verwendbar anstelle von: 132000020703 passend zu Steyr 667, 680, 968, 975, 9078, 9086, 9094, 9105, 9115, 9125, 9145, 6135 CVT, 6140 CVT, 6145 CVT, 6150 CVT, 6155 CVT, 6160 CVT, 6170 CVT, 6175 CVT, 6190 CVT, 6195 CVT, 9080 M, 9090 M, 9100M, 9080MT, 9085MT, 9090MT, 9095MT, 9100 MT, 9105 MT, CVT 120, 130, 150, 170, M 968, 975, 9078, 9086, 9094	104,90 87,40

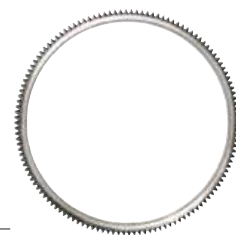

Riemenscheibe

Nr.	Bezeichnung	€
80503	Riemenscheibe 1R 17, Ø 75, ID 15 mm passend zu Steyr Gleichstromlichtmaschine	59,90 49,90



Umlenkrolle

Nr.	Bezeichnung	€
90762	Umlenkrolle zu CNH-Steyr 87300114 passend zu Steyr 6165 CVT, 6180 CVT, 6200 CVT, 6225 CVT	82,90 69,10



Regler

Nr.	Bezeichnung	€
54300	Regler Bosch 14V 11A	188,90 157,40
97260	Regler passend zu Bosch 14V - 11A	48,90 36,90
54321	Regler 14V zu Bosch (Hella)	21,90 18,30
54301	Regler zu Bosch 14,1V passend zu Iskra 11.125.049,11.125.003, Bosch 0192052001,0192052002, 0192052004,0192052005, 0192052006, 0192052008,0192052011,0192052012, 0192052014,0192052013,01922017, 0192052019,0192052022,0192052026, 0192052028,0192052031,0192052012, 1197311000,1197311001,1197311002, 1197311090, Lucas 01221152,21221347,21221373, 21931009, UVB 400,Magnetit Marelli, 64808010,64808011,64808012,648080100, 64808109,RTT110A,RTT110AB,RTT110ABT	14,90 12,40



Kühler

Nr. Bezeichnung €
 54389 Kühler 258,90
 verwendbar anstelle von: **229,00**
 845304, 184530004
 passend zu T80/T84
 passender Kühlerdeckel: 56606



95928 Kühler kurzer Hals 278,90
 verwendbar anstelle von: **248,90**
 845302, 184530002
 passend zu T80/T84



54553 Lagerungsscheibe für Kühler 2,90
2,40



61030 Kühler 689,00
 verwendbar anstelle von: **574,20**
 11800530044
 passend zu B182A,
 N180A, N182A



63154 Kühler 639,00
 verwendbar anstelle von: **532,50**
 11800530040, 1180530042,
 11800530070
 passend zu Steyr
 T180a, T182, T182a



54439 Kühler 409,00
 passend zu 188, 30, 430 **340,80**
 passender Kühlerdeckel: 56606

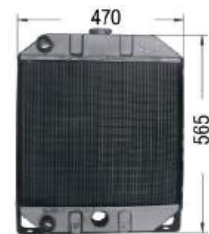

54440 Kühler 618,90
 passend zu 190/288/290 **515,80**
 passender Kühlerdeckel: 2 x 56606



54325 Kühler 348,90
 passend zu Plus 40, 540, 545,548, **290,80**
 50, 650, 658, 760, 768
 passender Kühlerdeckel: 53731



56607 Silentblock oben 1 Stk. 3,50
 verwendbar anstelle von: 188540117 **2,90**
 passend zu Steyr Plus

56608 Silentblock unten 1 Stk. 3,50
 verwendbar anstelle von: 92530024 **2,90**
 passend zu Steyr Plus



Nr. Bezeichnung €
 97760 Kühler 599,00
 verwendbar anstelle von: **499,20**
 1390530006
 passend zu Steyr Plus:
 70, 870, 980, 988

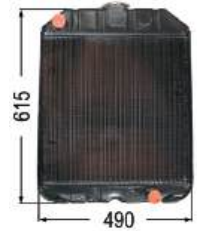

54413 Kühler 569,00
 passend zu Steyr Plus **474,20**
 90, 1090, 1100, 1108
 passender Kühlerdeckel: 56606



60938 Kühler 459,00
 verwendbar anstelle von: **382,50**
 131700530013
 passend zu 942, 948, 8045,
 C: 42, 48



54407 Kühler ohne Windleitblech 398,90
 passend zu 8055 **332,40**



54409 Kühler ohne Windleitblech 549,00
 passend zu 8065,08075 **457,50**
 passender Kühlerdeckel: 53731



54388 Kühler ohne Windleitblech 589,00
 passend zu 8080,8090,8110 **490,80**
 passender Kühlerdeckel: 53731



54408 Kühler ohne Windleitblech 599,00
 Halterung hinten motorseitig **499,20**



63160 Kühler ohne Windleitblech 559,00
 Halterung vorne grillseitig **465,80**
 verwendbar anstelle von:
 133700530004, 133700530025
 passend zu Steyr 8060, 8070
 passender Kühlerdeckel: 2 x 56606

74615 Kühler 599,00
 passend zu 8080-SK1 Turbo **538,90**
 passender Kühlerdeckel: 2 x 56606



Kühler

Nr. Bezeichnung €
 61029 Kühler 699,00
 verwendbar anstelle von: **582,50**
 135700530015
 passend zu 8085



Nr. Bezeichnung €
 60996 Kühler 689,00
 verwendbar anstelle von: **574,20**
 142000530020
 passend zu M: 9078, 9086, 9090, 9094,
 CS: 78, 86, 94



74663 Kühler 699,00
 passend zu 8100 **582,50**
 passender Kühlerdeckel: 2 x 56606



78238 Kühler 699,00
 passend zu Steyr **582,50**
 9086-9094/CS48-CS94



74664 Kühler 569,00
 passend zu 8130 SK2 Turbo **474,20**
 passender Kühlerdeckel: 53731



78247 Kühler 999,00
 passend zu 9105 **832,50**



78243 Kühler 518,90
 passend zu Steyr 948M-952M-958 **432,40**



78240 Kühler 899,00
 verwendbar anstelle von: **749,20**
 162000530001, 87574206,
 87737092
 passend zu Steyr 9115, 9125, 9145



78244 Kühler 639,00
 passend zu Steyr 955, 964, 970M **532,50**



91866 Kühler 499,00
 verwendbar anstelle von: **415,80**
 87574213, 87737094
 passend zu Steyr Profi
 6115, 6125, 6140;



78242 Kühler 590,00
 verwendbar anstelle von: **491,70**
 133153216
 passend zu Steyr
 968-975/CS68-CS75



Kühlerdeckel

Nr. Bezeichnung €
 84593 Kühlerdeckel 13,50
 verwendbar anstelle von: 18055122 **11,30**
 passend zu Steyr
 T: 80, 84, 86



78245 Kühler 419,00
 passend zu Steyr **349,20**
 M968, M975 MWM



53731 Kühlerdeckel 8,90
 verwendbar anstelle von: 133753001, **7,40**
 6592220, 4999682, 4075101, 590054,
 87569398, RE43593
 passend zu Steyr 948, 952, 958, 963, 968,
 975, 9078, 9086, 9094, Kompakt 360, 370,
 375, 485, 495, 9080 M, 9083 M, 9090 M,
 9100 M, M 948, 952, 958, 963, 968, 975,
 9078, 9083, 9086, 9094;



78241 Kühler 658,90
 passend zu 9078, 9083, 9086, 9094 **549,10**



56606 Kühlerdeckel 10,90
 verwendbar anstelle von: **9,10**
 3809530050-0505307



Kühlerdeckel

Nr.	Bezeichnung	€
90769	Kühlerdeckel zu CNH 82022744, 82004580 G = 45 mm verwendbar anstelle von: 82022744, 82004580 passend zu Steyr 9080MT,9090MT, 9095MT,9100MT,9105MT, Kompakt 4075,4085,4095,4105,4115, Multi 4095, 4105,4115, Profi 4100,4110,4115,4120, 4130,6115,6125,6135,6140, Profi CVT 4110,4120,4130, CVT 120,130,150,170, 6130,6135,6140,6145,6150,6155,6160, 6165,6170,6175,6180,6185,6190,6195, 6200,6205,6210,6215,6225,6230;	8,90 7,40



90770	Kühlerdeckel verwendbar anstelle von: 87306788 passend zu Steyr Profi 4100, 4110, 4115, 4120, 4130, 6115, 6125, 6135, 6140;	22,80 19,00
-------	---	-----------------------



90772	Kühlerdeckel verwendbar anstelle von: 87558952 passend zu Steyr Kompakt 4055, 4065, 4075, 4085, 4095;	39,90 33,30
-------	--	-----------------------



Ausgleichsbehälter

Nr.	Bezeichnung	€
64948	Ausgleichsbehälter verwendbar anstelle von: 82019583 passend zu CVT: 120, 130, 150, 170 Profi: 4100, 4115, 6115, 6125, 6135 Profi CVT: 4110, 4120, 4130	218,90 182,40



Wasserpumpen

Nr.	Bezeichnung	€
50873	Wasserpumpe passend zu T188	169,90 140,80
94497	Dichtung zu Wasserpumpe Steyr T188	16,50 13,80
63479	Wasserrohr zu Wasserpumpe 50873 verwendbar anstelle von: 1209010079 passend zu T188	46,90 39,10
63480	Dichtring für Wasserrohr zu Wasserpumpe 50873 verwendbar anstelle von: 1613V040008, 613V040008 passend zu T188	28,90 24,10



80661	Wasserpumpe verwendbar anstelle von: 1406A60007 passend zu Steyr T: 190, 288, 290	214,90 188,90
-------	---	-------------------------



52654	Wasserpumpe inkl. Deckel u. O-Ring verwendbar anstelle von: 30800050005 / 30800060008 / 30800060901E passend zu 540,650,658,768,8045, 650,670,760,548,942,948	168,90 140,80
-------	--	-------------------------



63424	Wasserpumpe mit Deckel, Ring und Heizungsanschluss verwendbar anstelle von: 4080060014, 3080006008, 30800050005, 30800060901E, 3080060009E passend zu 548, 650, 658, 760, 768, 942, 948, 8045	498,50 165,40
-------	---	-------------------------



Nr.	Bezeichnung	€
54309	O-Ring groß zu Wasserpumpe Steyr Plus	6,90 5,80
54310	Deckel zu Wasserpumpe Steyr Plus	11,90 9,90
60781	Wasserrohr zu 52654 38 x 45 mm	8,90 7,40
60780	Wasserrohr zu 52654 25 x 16,5 mm	6,70 5,60
60779	Wasserrohr zu 52654 22 x 45 mm	7,50 6,30



Wasserpumpen

Nr.	Bezeichnung	€
60882	Wasserpumpe verwendbar anstelle von: 4090606, 409060032, 409060033, 610T0601, 610T060004, 610T060011, 610T060012 passend zu 70, 90, 870, 980, 988, 1090, 1100, 1108, 1200	418,90 369,00



52657	Wasserpumpe mit einfacher Riemenscheibe Riemen 13 mm verwendbar anstelle von: 31100060093 / 31100060905E passend zu 8065,8075,8085,8100, 8110, 8120,8130,SK2 8060,8070, 8075,8080,8090	214,90 179,10
-------	---	-------------------------



52660	Wasserpumpe mit doppelter Riemenscheibe verwendbar anstelle von: 31100060017 / 31100060901E passend zu 8065,8100,8110, 8120,8130	214,90 179,10
-------	---	-------------------------



52663	Wasserpumpe mit doppelter Riemenscheibe verwendbar anstelle von: 31100060034 / 31100060901E passend zu 8060,8070,8075,8080,8090	198,90 165,80
-------	---	-------------------------



61531	Wasserpumpe mit Viscolüfter verwendbar anstelle von: 161100060055 passend zu Steyr 8130 mit Viscolüfter	299,90 249,20
-------	---	-------------------------



10138	Wasserpumpe verwendbar anstelle von: 130100060703	70,20 58,50
-------	---	-----------------------



54141	Wasserpumpe verstärkt für Viscolüfter passend zu 955A,964A,970,968A,975A, M9083A,M9078A,M9086A,M9094A, WD40180-181-182-185, WD30142-143	104,90 87,40
-------	--	------------------------



Wasserpumpen

Nr. Bezeichnung €

78189 Wasserpumpe ~~179,90~~
passend zu Steyr CS68-105 Sisu **149,90**



80270 Wasserpumpe ~~149,00~~
verwendbar anstelle von: **124,20**

162000060735
passend zu 9105,
9115,9155,
9170,
8180A



78226 Wasserpumpe ~~88,90~~
verwendbar anstelle von: **74,10**

365375A1
passend zu Steyr
48,52,58,63,CX50,CX60



50874 Wasserpumpe ~~228,90~~
passend zu 8055 **190,80**



50875 Wasserpumpe ~~184,90~~
verwendbar anstelle von: **154,10**

836864481, 162084060704
passend zu Steyr
9115, 9125, 9145
CVT: 120, 130, 150, 170;



96807 Wasserpumpe ~~145,90~~
verwendbar anstelle von: **121,60**

504216828,
504264335
passend zu Steyr
Kompakt: 4055,
4065, 4075



98238 Wasserpumpe ~~299,00~~
verwendbar anstelle von: **249,20**

47107748
passend zu Steyr CVT: 120, 130,
150, 170, 6135, 6145,
6155, 6170, 6190



78227 Wasserpumpe ~~91,20~~
verwendbar anstelle von: **76,00**

2852114, 87803065, 504062854, 4891252
passend zu Steyr Profi 4100, 4110, 4115,
4120, 4130, 6115, 6125, 6135, 6140,
Kompakt 495, 4085, 4095;



90723 Wasserpumpe ~~93,50~~
verwendbar anstelle von: **77,90**

2854835
passend zu CVT 6115, 6125, 6130,
6140, 6145, 6160, 6165, 6170, 6180,
6185, 6200, 6205, 6210, 6215, 6225,
6230, Profi 4110, 4120, 4130;



Nr. Bezeichnung €
54327 Wasserpumpen Rep-satz ~~68,90~~
verwendbar anst. von: 407 06 0601 **57,40**
passend zu Plus 40,540,545,548,
50,650,658,760,768,8045,
942,948,C42,C48



53860 Wasserpumpen Rep-satz ~~81,90~~
passend zu 190/288/290 **68,30**



53859 Wasserpumpen Rep-satz ~~86,90~~
passend zu 8055 bis BJ 85, **72,40**
Wellenlänge 144 mm



53831 Wasserpumpen Rep-satz ~~93,30~~
passend zu 8055,8060, **77,80**
8065,8070,8075,
8080,8085,8090 ab Bj 85



54292 Wasserpumpen Rep-satz ~~112,90~~
passend zu 8055,8060,8065, **94,10**
8070,8075,8080,q8085,8090 bis Bj 85



54218 Dichtung ~~8,90~~
passend zu Wasserpumpe Serie 80 **7,40**



53560 Wasserpumpen Rep-satz ~~68,90~~
passend zu T188 **57,40**

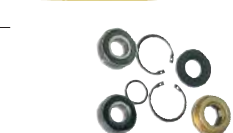

53559 Wasserpumpen Rep-satz ~~68,90~~
passend zu Plus 70-816570,870,980, **57,40**
1090,8140,8150,8160,8165



53561 Wasserpumpen Rep-satz ~~98,90~~
passend zu Serie 80 FK1 **82,40**



80269 Flügelrad ~~15,60~~
passend zu T80 **13,00**



92271 Dichtung zu Wasserpumpe ~~3,90~~
passend zu T80/84 **3,30**



54149 Gleitring ~~25,90~~
passend zu Serie 80 **21,60**



54192 Gleitring 35 x 16 ~~16,90~~
passend zu Serie T80/T84 **14,10**



54193 Gleitring 36,7 x 16 ~~16,90~~
14,10



54243 Gleitring AD = 53, mm ID = 27,5 mm ~~14,90~~
passend zu Serie Plus **12,40**



Temperaturanzeige

Nr. **Bezeichnung** **€**
53703 **Temperaturanzeige 12V,** **32,90**
 Ø 52 mm **27,40**
verwendbar anstelle von: 1925840
passend zu Steyr
 Serie Plus



53714 **Temperaturgeber** **18,90**
verwendbar anstelle von: M14 **15,80**
passend zu Steyr Serie Plus



64739 **Temperaturgeber** **28,90**
verwendbar anstelle von: **24,10**
 VDO80511, 132000060724
passend zu 548, 658, 768, Plus Serie



53592 **Temperaturanzeiger** Ø 60 mm **32,90**
 mechanisch Länge 1600 mm **27,40**
 Gewinde M10x1,0,
 mit Beleuchtung 12V,
 Temperaturbereich 40 - 120°



51588 **Adapter AG = M14 x 1,5** **11,50**
 IG = M10 x 1 **9,60**



Windflügel

Nr. **Bezeichnung** **€**
80676 **Windflügel** **29,90**
 Ø = 400 mm **24,90**
verwendbar anstelle von:
 40800060032
passend zu Steyr Plus



90760 **Lüfter mit Viscokupplung** **289,00**
verwendbar anstelle von: **240,80**
 47135806
passend zu Steyr
 Kompakt 485, 495



97094 **Viscokupplung** **319,00**
verwendbar anstelle von: **265,80**
 81862862



90899 **Viscokupplung** **229,00**
verwendbar anstelle von: **190,80**
 161200060470
passend zu Steyr
 9105, 9115, 9125, 9145;



90900 **Viscokupplung** **158,90**
verwendbar anstelle von: **132,40**
 87334143, 13100060110
passend zu M: 9080, 9090, 9100;



Thermostate

Nr. **Bezeichnung** **€**
54442 **Thermostat** **54,90**
verwendbar anstelle von: 180530064 **46,90**
passend zu T80, T84, T86, T180/188



21763 **Thermostat 82°** **11,90**
passend zu 188, 190, 288, 290 **9,90**



52707 **Thermostat 87°** **42,90**
verwendbar anstelle von: **35,80**
 192530005 /192530034
passend zu Serie plus 30, 40, 50,
 430, 540, 545, 548, 650, 658, 760,
 768, 942, 948, C42, C48, 8045



63426 **Thermostat 87° neue Ausführung** **78,90**
verwendbar anstelle von: 31100060065 **65,80**
passend zu 8070, 8075, 8080, 8090,
 8100, 8110, 8120, 8130



52709 **Thermostat 87°** **78,90**
verwendbar anstelle von: 31100060065 **65,80**
passend zu 8070, 8075, 8080, 8090, 8100,
 8110, 8120, 8130



09304 **Thermostat 80°** **98,90**
verwendbar anstelle von: 1409060002 **82,40**
passend zu 70 90, 870, 980, 988,
 1090, 1108, 1100, 1200



52712 **Thermostat 87°** **38,90**
verwendbar anstelle von: **32,40**
 31100040036
passend zu 8055



92622 **Thermostat** **334,90**
verwendbar anstelle von: **279,10**
 299992A1, 6299992A1
passend zu Steyr: 948, 958;



52714 **Thermostat 85°** **75,90**
verwendbar anstelle von: **63,30**
 130100061003, 130100061001
passend zu 955, 964, 968, 970, 975.
 9078, 9083, 9086, 9094
 mit MWM Motor



61529 **Thermostat** **98,90**
verwendbar anstelle von: **82,40**
 41390428
passend zu Steyr T180a,
 T182, T185, T280



90763 **Thermostat 79°C** **17,90**
verwendbar anstelle von: 98463637 **14,90**
 87608577, 5088484, 4569187,
 4703088, 4823210, 4823211, 4823226
passend zu Kompakt 360, 370, 375;



90765 **Dichtung** **5,90**
verwendbar anstelle von: 99450535 **4,90**
passend zu Steyr Kompakt
 360, 370, 375;



60812 **Thermostat** **35,60**
verwendbar anstelle von: **29,70**
 132000060709, 836115718,
 132000060726, 132000060708



Kühlerschlauch

mit Textileinlage

Länge 1 Meter, Betriebsdruck 3 bar
Temperaturbereich -40 bis 120 Grad,

Nr.	Bezeichnung	ID	AD	€
52691	Kühlerschlauch	38	48	22,90 19,10
61905	Kühlerschlauch	40	48	24,90 20,80
52694	Kühlerschlauch	45	55	25,90 21,60

Nr.	Bezeichnung	€
53695	Kühlerschlauch verwendbar anstelle von: 192530012	8,90 7,40

Nr.	Bezeichnung	€
99864	Kühlwasserschläuche Ø = 38 mm passend zu T180a, T182	26,90 22,40

Nr.	Bezeichnung	€
99865	Kühlwasserschläuche Ø = 15, 38 mm passend zu N180a, N182a	26,90 22,40

Nr.	Bezeichnung	€
99866	Kühlerschlauch unten Ø = 35 L = 116 passend zu T190, T288, T290	48,90 15,80

Nr.	Bezeichnung	€
99867	Kühlwasserschläuche Ø = 15, 38 mm passend zu T188	39,90 33,30

Nr.	Bezeichnung	€
99870	Kühlerschlauch nach unten Ø = 38 mm passend zu T188	26,90 22,40

Nr.	Bezeichnung	€
99869	Kühlwasserschläuche Ø = 20, 34, 38 mm passend zu T190	29,90 24,90

Nr.	Bezeichnung	€
89783	Kühlerschlauch oben verwendbar anstelle von: 133700530027 passend zu 8055 ID = 37 mm	32,90 27,40

Nr.	Bezeichnung	€
89784	Kühlerschlauch unten verwendbar anstelle von: 1192530032 passend zu 8055 ID = 37 mm	46,90 39,10

Nr.	Bezeichnung	€
89785	Kühlerschlauch oben verwendbar anstelle von: 135700530013 passend zu 8060, 8065, 8070, 8075, 8080, 8090, 8100, 8110, 8120, 8130 ID = 37 mm	34,90 26,60



Kühlerschläuche

Nr.	Bezeichnung	€
89786	Kühlerschlauch unten verwendbar anstelle von: 137700530007 passend zu 8060, 8065, 8075, 8080, 8085, 8090, 8100, 8120, 8130 ID = 44 mm	30,90 25,80

Nr.	Bezeichnung	€
89787	Kühlerschlauch oben verwendbar anstelle von: 130300530013 passend zu M 952, M 963 ID = 32 / 34 mm	48,90 40,80

Nr.	Bezeichnung	€
89788	Kühlerschlauch oben verwendbar anstelle von: 133153014 passend zu 968, 975, 9078, 9086, 9094 ID = 50 / 37 mm	53,90 44,90

Nr.	Bezeichnung	€
89789	Kühlerschlauch oben verwendbar anstelle von: 132000530004 passend zu 968, 975, 9078, 9086, 9094, 9105, 9115, 9125 ID = 38 mm	47,90 39,90

Nr.	Bezeichnung	€
89790	Kühlerschlauch unten verwendbar anstelle von: 132000530003 passend zu 968, 975, 9078, 9086, 9094, 9105, 9115, 9125 ID = 38 mm	39,90 32,90

Nr.	Bezeichnung	€
89791	Kühlerschlauch oben 162000530009 passend zu 9105, 9115, 9125, 9145 ID = 40 / 45 mm	99,00 82,50

Nr.	Bezeichnung	€
89792	Kühlerschlauch unten verwendbar anstelle von: 162000530011 passend zu 9105, 9115, 9125, 914 ID = 45 / 55 mm	89,90 74,90

Nr.	Bezeichnung	€
89793	Kühlerschlauch oben verwendbar anstelle von: 5176675 passend zu Steyr Kompakt 360, 370, 375; ID = 38 / 45 mm	24,90 20,80

Nr.	Bezeichnung	€
89794	Kühlerschlauch unten verwendbar anstelle von: 5096235 passend zu Kompakt 360, 370, 375; ID = 37 mm, Länge = 80 mm	5,90 4,90

Nr.	Bezeichnung	€
89795	Kühlerschlauch By-Pass verwendbar anstelle von: 162000530113, 47107881 passend zu CVT 120, CVT 130, CVT 150, CVT 170 ID = 17 / 22 / 22 mm	139,40 116,20

Nr.	Bezeichnung	€
89796	Kühlerschlauch oben verwendbar anstelle von: 162000530104 passend zu CVT 120, CVT 130, CVT 150, CVT 170, 6135 CVT, 6145 CVT, 6155 CVT, 6170 CVT, 6190 CVT ID = 54 mm	70,80 59,00



Einspritzdüsen

Nr.	Bezeichnung	€
54284	Düsenhalter kpl. WD-308 - 408 verwendbar anstelle von: 30800080040	289,00 240,80
91932	Federteller passend zu F&M Düsenstock	25,90 21,60
91933	Zwischenstück passend zu F&M Düsenstock	49,90 41,60
54100	Einspritzdüse L = 27 mm verwendbar anstelle von: 12130080112 passend zu T80,T84,T180,T182,T185	49,90 16,60
54101	Einspritzdüse L = 27 mm verwendbar anstelle von: 1609B080023 passend zu T188	31,90 26,60
54123	Einspritzdüse verwendbar anstelle von: 1413C081500x passend zu 188,190,288,290	32,90 27,40
54113	Einspritzdüse verwendbar anstelle von: 0433271164 passend zu Serie Plus 40-768	32,90 27,40
54102	Einspritzdüse L = 53 mm verwendbar anstelle von: 1311100080020 / 1311100080034 passend zu 8055,8060,8065,8070, 8075,8080,8090,8070,FK1,8075 RS1, 8080 FK1,8100,8110,8120,8130 SK2	28,90 24,10
54103	Wärmeschutzhülle L = 25 mm verwendbar anstelle von: 1614080081	8,90 7,40
54127	Einspritzdüse passend zu Plus 70,430,870,980,988, 1090,1108,1111,1200,1300,8140,8160	28,90 24,10



Dichtungen

Nr.	Bezeichnung	€
54550	Dichtung zu Einspritzl. klein L ohne Hals	4,60 3,80
54551	Dichtung zu Einspritzleitung klein 4 mm	8,40 7,00
54552	Dichtung zu Einspritzleitung groß, 6 mm	5,90 4,90
40498	Kupferdichtring f. Einspritzdüse Motortype: AD3.152,AT3.152,AD4.203, A4.212,A4.236,A4.248,A4.318,AT4.236, A6.354.4,A6.354,A6.354.1 verwendbar anstelle von: 0921173 passend zu 135-3610	1,40 1,20
64811	Dichtring-Einspritzdüse verwendbar anstelle von: 81806277, 1806277, 84548310, C5NE9F596A passend zu CVT: 6130, 6145, 6150, 6160, 6165, 6170, 6175, 6185, 6205, 6215, 6230, 6250 Terrus Multi: 4100, 4110, 4120, Profi: 4110, 4115, 4120, 4125, 4130, 4135, 4145, 6115, 6125, 6140, 6145	1,40 0,90



Glühkerzen

Nr.	Bezeichnung	€
54062	Glühkerze 1,7V 43A passend zu T80,84,86, 180,182,280,380	45,90 34,90
96004	Anschlussisolator zu Glühkerze 54062 verwendbar anstelle von: 2130926, 1213a090028 passend zu T: 80, 84, 86, 180,	8,90 7,40
54063	Glühkerze 10,5V 10A Gewinde M14x1,25 passend zu 188, 190, 288, 290, 586, 780, 880	29,90 24,90
54064	Glühkerze 11V 50A Gewinde M22x1,5 passend zu 8060, 8070, 8080, 8100, 8120	39,90 33,30
54304	Vorglühschraube verwendbar anstelle von: 210090008 passend zu Steyr Plus	9,90 8,30
95985	Isolierung für Vorglühschraube passend zu Steyr Plus	1,90 1,60
95986	Hülse für Glühanlage passend zu Steyr Plus	5,90 4,90
74617	Glühkerze Gewinde M20x1,5 passend zu Steyr 900,9078 - 9094	49,90 41,60
97099	Flammglühkerze 12V Gewinde 1/2" verwendbar anstelle von: 5161845, 5086043, 1609080090 passend zu Steyr: Kompakt: 360, 370, 375, 4065, 4075	17,90 14,90
54067	Glühwiderstand passend zu Steyr 2 Zylinder	49,90 16,60
54068	Glühwiderstand passend zu Steyr 3 Zylinder	23,90 19,90
54069	Glühwiderstand passend zu Steyr 4 Zylinder	23,90 19,90
84585	Vorglühlung verwendbar anstelle von: 845828 passend zu Steyr T80, 84, 86, 180, 185, 280	29,90 24,90
84589	Vorglühdraht verwendbar anstelle von: 805850, 11390903 passend zu Steyr T80/280	12,90 10,80
84590	Vorglühdraht verwendbar anstelle von: 1805835 passend zu Steyr T180, 182, 185, 280	11,90 9,90



Heizelemente

Nr. **Bezeichnung** **€**
80008 Heizelement **169,00**
 zu Type: Serie Plus **140,80**
 8055,8060,8065,8070,8075,8080,8090,
 8110,8130,8150,8165,8180,942,948
 Kabelsatz 1m 80034 dazu
 verwendbar anstelle von: RE167



80017 Heizelement **169,90**
 zu Motor: Sisu **141,60**
 zu Type: M968,975,9078,9080,9080T,
 9085,9086,9090,9090T,9094,9095T,
 9100,9100T9105T
 Kabelsatz 1m 80034 dazu
 verwendbar anstelle von: RE234



80021 Heizelement **198,90**
 zu Type: CVT120,130,150,170,6135,6140,
 6145,6150,6155,6170,6175,6190,6195
 Kabelsatz 1m 80034 dazu
 verwendbar anstelle von: RE238



Kabelsätze

Nr. **Bezeichnung** **€**
80034 Kabelsatz **181,90**
 Länge 1 m **151,60**
 verwendbar anstelle von: MKMS1025



80035 Kabelsatz **182,90**
 Länge 1,5 m **152,40**
 verwendbar anstelle von: MKMS1525



Kraftstoffpumpen

Nr. **Bezeichnung** **€**
54104 Kraftstoffpumpe **74,90**
 verwendbar anstelle von: **62,40**
 61060080701



54109 Schauglas lose **5,90**
4,90



54110 Filter lose **3,00**
2,50



54111 Dichtung lose **1,30**
1,10



54112 Feder lose **1,90**
1,60



54120 Handpumpe lose **11,90**
 M16x1,5 **9,90**



86142 Handpumpe M16x1,5 **15,90**
 verwendbar anstelle von: **13,30**
 9968879,9969346



63321 Kraftstoffhandpumpe M16 x 1,5 **49,90**
 verwendbar anstelle von: **16,60**
 Bosch 51.12150-7021, 2447222126



96048 Dieselpumpe **49,90**
 verwendbar anstelle von: 213F0805 **41,60**
 passend zu Steyr T: 182, 180a



94805 Kraftstoffförderpumpe **42,90**
 Motortypen: Perkins 6.288, **35,80**
 6.305, 6.340, 6.354, 6.372,
 verwendbar anstelle von: 4222093M91,
 3637309M91, 2641372, 2641A064
 passend zu Steyr Serie 80



Kraftstoffpumpen

Nr. **Bezeichnung** **€**
53949 Kraftstoffpumpe **48,20**
 verwendbar anstelle von: 354236A1 **40,20**
 passend zu 968,975,9078,9086,
 9094,9105,9115,9125,9145



65692 Kraftstoffförderpumpe **159,00**
 zu Steyr 8100, 8110, 8120, 8130 **132,50**



02111 Dieselpumpe **33,90**
 verwendbar anstelle von: **28,30**
 303000080739
 passend zu 948,952,958,963,
 CVT120,130,150,170



03680 Kraftstoffpumpe **23,90**
 verwendbar anstelle von: **19,90**
 140100080709 / 130100080733
 / 140100080702
 passend zu Motor MWM WD 401,
 9078, 9083, 9086, 9094, 955,
 964, 968, 970, 975, M9078, M9083,
 M9086, M9094, M968, M975



54122 Dieselpumpe **104,90**
 passend zu 185A,188N,280A, **87,40**



90761 Handpumpe **99,60**
 verwendbar anstelle von: 4890811 **83,00**
 passend zu Steyr Profi 4110,
 4115, 4120, 4130,
 6115, 6125, 6135, 6140



61503 Kraftstoffpumpe **238,20**
 verwendbar anstelle von: **198,50**
 84288071,162000080881,
 162000080883, 47111570,
 47111572, 4225711M1, MP10325
 passend zu Steyr: CVT: 6135,
 6145, 6155, 6170, 6190; Perkins



Tank

Nr. **Bezeichnung** **€**
56609 Tank **318,90**
 verwendbar anstelle von: **278,90**
 050550020-292550070
 passend zu Steyr Serie Plus



60783 Stahlband **11,40**
 verwendbar anstelle von: **9,50**
 28055029
 passend zu Steyr Serie Plus



60784 Spannsatz **13,90**
 verwendbar anstelle von: **11,60**
 292550034
 passend zu Steyr Serie Plus



Tankgeber

Nr. Bezeichnung €
 56610 Geber Gewinde M22 ~~32,90~~
 verwendbar anst. von: 292550132 **27,40**
 passend zu Serie Plus



91898 Tankgeber Gewinde M12 ~~48,90~~
 verwendbar anstelle von: 1885570 **40,80**
 passend zu Steyr 188, 190,
 288, 290, Plus Serie



86091 Tankgeber L = 520 mm ~~209,90~~
 passend zu Serie 8055 **174,90**



54132 Tankgeber L = 620 mm ~~245,90~~
 passend zu Serie 80 SK2 **204,90**



91009 Tankgeber ~~289,00~~
 verwendbar anstelle von: **240,80**
 87606282
 passend zu Steyr Profi 4100,
 4115, 6115, 6125, 6135, 6140



91010 Tankgeber ~~278,90~~
 verwendbar anstelle von: **232,40**
 87606283
 passend zu Steyr Profi 4100,
 4110, 4115, 4120, 4130;



Diesel Ablasshahn

Nr. Bezeichnung €
 54329 Diesel Ablasshahn ~~20,90~~
 verwendbar anstelle von: **17,40**
 280550068
 passend zu Plus 40, 540, 545,
 548, 50, 650, 658, 60, 768, 8045

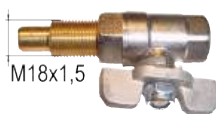

Einspritzung

Nr. Bezeichnung €
 89910 Einspritzpumpe ~~1599,00~~
 passend zu Steyr **1332,50**
 548 WD308.45



89906 Einspritzpumpe ~~1599,00~~
 passend zu Steyr **1332,50**
 650 WD407



89908 Einspritzpumpe ~~1599,00~~
 passend zu Steyr **1332,50**
 768 WD408.43



Einspritzung

Nr. Bezeichnung €
 89907 Einspritzpumpe ~~1599,00~~
 passend zu Steyr **1332,50**
 870 WD410



89911 Einspritzpumpe ~~1599,00~~
 passend zu Steyr **1332,50**
 8055 WD311.44



89909 Einspritzpumpe ~~1599,00~~
 passend zu Steyr **1332,50**
 8080 WD411.85



93672 Dichtsatz ~~86,90~~
 passend zu **72,40**
 Friedmann-Maier
 Einspritzpumpe P23



93673 Dichtsatz ~~73,90~~
 passend zu **61,60**
 Friedmann-Maier
 Einspritzpumpe P24



Abstellmagnet

Nr. Bezeichnung €
 89797 Abstellmagnet ~~25,90~~
 verwendbar anstelle von: **21,60**
 218323A1
 passend zu 243, 253, 263, 352,
 355, 396, 399, 3075, 3085, 3095,
 3115, 3125, 3315, 3325, 3330,
 3340, 3350, 3355, 3635, 3640,
 3645, 3655, 4215, 4220, 4225,
 4235, 4240, 4245, 4255, 4260,
 4265, 4270, 6140, 6150, 6160,
 6170, 6180, 6235, 6245, 6255,
 6260, 6265, 6270, 6280, 6290,
 8120, 8210, 8220



89799 Abstellmagnet ~~248,90~~
 verwendbar anstelle von: **182,40**
 140271023
 passend zu Steyr: 955, 964, 970,
 9078, 9083, 9086, 9094



Tankdeckel

Nr.	Bezeichnung	€
99382	Tankdeckel mit Schraubgewinde passend zu Steyr	24,90 18,30
96052	Dichtung zu Tankverschluss Maße: 84 x 60 x 3 mm verwendbar anstelle von: 2205515 passend zu Steyr T: 80,84,86	3,90 3,30
53573	Tankdeckel Ø 80 mm	10,90 9,10
97893	Tankdeckel versperrbar Ø 80 mm passend zu Steyr	26,90 22,40
84587	Sieb für Tank Ø 50 mm	14,90 12,40



Kraftstoffleitung kpl.

Typ A in NW 8, beidseitig mit Ringnippel



Nr.	Bezeichnung	D	L	€
74665	Kraftstoffleitung	14	200	14,90 12,40
74666	Kraftstoffleitung	14	250	16,90 14,10
74667	Kraftstoffleitung	14	300	17,90 14,90
74668	Kraftstoffleitung	14	350	18,90 15,80
74669	Kraftstoffleitung	14	400	20,90 17,40
74670	Kraftstoffleitung	14	450	20,90 17,40
74671	Kraftstoffleitung	14	550	24,90 18,30
74672	Kraftstoffleitung	14	650	22,90 19,10
74673	Kraftstoffleitung	14	750	22,90 19,10

Lamellen

Nr.	Bezeichnung	€
90894	Außenlamelle-Lastschalt- u. Zapfwellenkupplung 2,2 mm stark, IØ = 98,1 mm, AØ = 152,3 mm verwendbar anstelle von: 5173295 passend zu Steyr Kompakt 360,370, 375,485,495,4055,4065,4075,4085, 4095, Profi 4100,4110,4115, 4120,4130, 6115,6125,6135,6140, CVT 6130, 6145,6160,6165,6170,6180,6185,6200, 6205,6210,6225,6230;	8,20 6,80
94392	Außenlamelle verwendbar anstelle von: 188220017 passend zu Steyr 430, 540, 545, 650	19,90 16,60
94393	Innenlamelle verwendbar anstelle von: 188220016 passend zu Steyr 430, 540, 545, 650	19,90 16,60
94394	Außenlamelle verwendbar anstelle von: 288220017 passend zu Steyr	12,90 10,80

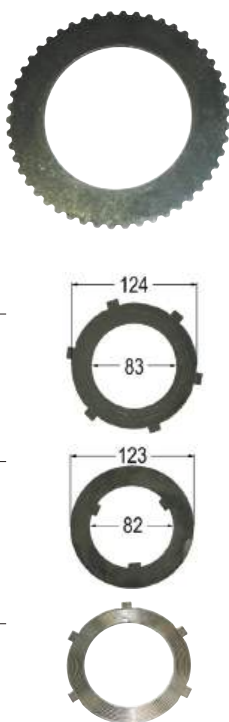

Lamellen

Nr.	Bezeichnung	€
94395	Innenlamelle verwendbar anstelle von: 288220016 passend zu Steyr	12,90 10,80
94396	Druckring-Zapfwellenkupplung 9,5 mm stark, IØ = 70 mm, AØ = 109 mm verwendbar anstelle von: 19227085 passend zu Steyr Plus Serie 540/548	99,10 82,60
94397	Federteller-Zapfwellenkupplung 2,5 mm stark, IØ = 35 mm, AØ = 88 mm verwendbar anstelle von: 292220098 passend zu Steyr Plus Serie	24,90 20,80
63328	Nabe ID = 60/110 mm, AD = 138 mm 8 Zähne, Höhe = 18 mm verwendbar anstelle von: 140800160709 passend zu Steyr Plus Serie	58,90 49,10



Bremse

Nr.	Bezeichnung	U x B x S	Nieten dazu	€
53780	Bremsbelag passend zu T80 - T86	350x60x6	4x10	18,90 15,80
53557	Bremsbelag passend zu T180- T182-T185	445x60x8	5x12	24,90 18,30
56403	Bremsbelagsatz passend zu T180 (4 Stk.)	435/70/8	5x12	99,90 83,30
53787	Bremsbelag passend zu Plus und T188, Plus 30	415x50x6	4x10	23,90 19,90
51328	Bremsbelag passend zu T190	240x60x5	4x10	23,90 19,90
51329	Bremsbelag passend zu T288	290x60x6	4x10	24,90 18,30
53785	Bremsbelag passend zu Plus 40, 540, 548	265x60x10	4x10	29,60 24,70
53786	Bremsbelag passend zu Plus 50, 650,760,768	300x60x10	4x10	24,00 20,00
94418	Bremsbelag vorne passend zu Steyr 540, 548, 650, 658, 760, 768	265x80x7	6x12	32,90 27,40
51331	Bremsbelag passend zu Plus 70, 870,90,1090	270x60x5	4x10	27,90 23,30
80149	Bremsbelag verwendbar anstelle von: 3226414R2 passend zu 988,1100,1108	272 x 60		17,90 14,90
51332	Bremsbelag passend zu Plus 988,1100,1108	270x60x5,3	5x12	29,60 24,70



Bremse

Nr.	Bezeichnung	€		Nr.	Bezeichnung	€	
92399	Bremsbacke 60 x 255 mm verwendbar anstelle von: 1295340725, 1295340903 passend zu Steyr 288, 290, Plus: 650, 658, 760, 768	94,90 79,10		77474	Bremsklötze 4 Stk. 90 x 15 x 71 verwendbar anstelle von: 135700441804 passend zu 970,C55,64,70	31,90 26,60	
92400	Bremsbacke 60 x 255 mm verwendbar anstelle von: 1295340007, 1295340901, 25242.01 passend zu Steyr 650, 650A, 650/50, 658, 760, 768 (hydraulische Betätigung)	71,90 59,90		80129	Bremsklötze 2 Stk. 90 x 70 x 15 verwendbar anstelle von: 135700441804 passend zu M948, 958, 952, 963, 968, 975, CS48, 52, 58, 63, 68, 75	21,90 18,30	
92401	Bremsbacke 60 x 255 mm verwendbar anstelle von: 1295340902, 1295340914 passend zu Steyr Plus: 658, 760, 7 68, 768A (hydraulische Betätigung)	78,90 65,80		77495	Bremsscheibe 242 mm, 28 Z verwendbar anstelle von: 155700340044 passend zu M9078,9080M,9083,9086, 9090M,9094,9100MCS78,86,94,80,90100, CVT6135,6145,6155,6170,6190,6195,9105, 9115,9125,9145,CS100,110,120,130,150, CVX1135,1145,1155,1170,1190,1195, 120,130,150,170	94,90 79,10	
53777	Handbremsbacke passend zu 8060,8070,8080,8090	49,90 41,60		77496	Platte 248 mm verwendbar anstelle von: 133000340022 passend zu M9078,9080M,9083,9086, 9090M,9094,9100MCS78,86,94,80,90100, CVT6135,6145,6155,6170,6190,6195,9105, 9115,9125,9145,CS100,110,120,130,150, CVX1135,1145,1155,1170,1190,1195, 120,130,150,170	58,20 48,50	
90318	Handbremsbacke 168/60/6 verwendbar anstelle von: 137700349709 passend zu Steyr 8100, 8110, 8120, 8130	109,90 91,60		77497	Bremsautomat 242 mm verwendbar anstelle von: 133000340015 passend zu M9078,9080M,9083,9086, 9090M,9094,9100M, CS78,86,94,80,90 100,CVT6135,6145,6155,6170,6190, 6195,9105,9115,9125,9145 CS100,110,120,130,150, CVX1135,1145,1155,1170, 1190,1195,120,130,150,170	499,00 415,80	
53778	Bremsbacke (hydraulisch) passend zu 8060,8070,8080,8090	56,90 47,40		77498	Bremsscheibe 243 mm, 28 Z verwendbar anstelle von: 133000340016 passend zu CVT6135,6145,6155,6170, 6190,6195,9105,9115,9125,9145 CS100,110,120,130,150, CVX1135,1145,1155,1170, 1190,1195,120,130,150,170	98,90 82,40	
53779	Bremsbacke passend zu 8055,8065,8075,8085,8095, 8100,8110,8120,8130, 955,964,970	58,90 49,10		77499	Bremsscheibe 327 mm verwendbar anstelle von: 5191497 passend zu 12Z4100,4110,4115, 4120,4130,6115,6125,6135,6140	478,90 149,10	
60805	Rückzugsfeder verwendbar anstelle von: 288350093 passend zu Steyr 50, 430, 540, 545, 650, 658,760, 768, 8055, 8065, 8085, 8095 T: 190, 288, 290	4,50 3,80		90855	Bremsscheibe verwendbar anstelle von: 5180633 passend zu Steyr Kompakt 360, 370, 375, 485, 495, 4065, 4075, 4085, 4095	214,90 179,10	
54485	Bremstrommel Ø 230 mm innen verwendbar anstelle von: 295340031 passend zu 50,650,60,760,768	101,90 84,90		89948	Bremsscheibe 165 mm, 23 Z verwendbar anstelle von: 133700340106 passend zu 942, 948, 955, 964, 970, M948, 952, 958, 963, 968, 975	88,90 74,10	
78491	Bremstrommel verwendbar anstelle von: 137700349025 passend zu 8100-8130	246,90 205,80					
77446	Bremsbacke 1 Stk. 50 x 200 verwendbar anstelle von: 131700340014 passend zu 942,948,8045	63,90 53,30					
77445	Bremstrommel 200 mm innen verwendbar anstelle von: 131700340001 passend zu 942,948,8045	104,50 87,10					
53781	Bremsklötze 2 Stk. verwendbar anstelle von: 8100-8130	46,50 13,80					

Bremse

Nr.	Bezeichnung	€		Nr.	Bezeichnung	€	
89949	Bremsscheibe 170 mm, 12 Z verwendbar anstelle von: 133744605 passend zu 9078,9086,9094,M968, M975,M9078,M9083,M9086,M9094, 9080M,9090M,9100M, 9080MT,9085MT, 9090MT,9095MT,9100MT,9105MT	62,90 52,40		61627	Ausgleichsbehälter verwendbar anstelle von: 133135400 passend zu Steyr 942, 948, 955, 964, 970,6140,6150,6160,6175,6195,8060, 8070,8080,8090,8100,8110,8120,8130, 9078, 9086, 9094, 9105, 9125, 9145, M: 948, 952, 958, 963, 968, 975, 9078, 9083, 9086, 9094, 9080, 9090, 9100	43,90 36,60	
89951	Bremsscheibe 223 mm, 28 Z verwendbar anstelle von: 155700340029 passend zu 9078, 9086, 9094, 9105, 9115, 9125, 9145, M 9078, 9083, 9086, 9094	74,90 59,90		77463	Radbremszylinder verwendbar anstelle von: 1295340601 passend zu 540, 545, 650, 760	98,90 82,40	
89952	Platte 228 mm verwendbar anstelle von: 155700340030 passend zu 9078,9086,9094,9105,9115, 9125,9145, M9078,9083,9086,9094	49,40 41,20		77460	Radbremszylinder (ohne Nachstellung) Vorderachse verwendbar anstelle von: 1190440706 passend zu 540, 545, 650, 658, 760, 768	164,90 137,40	
90867	Bremsklotz beidseitig verwendbar anstelle von: 5196706 passend zu Steyr CVT 6165, 6170, 6180, 6185, 6200, 6205, 6210, 6215, 6225, 6235;	47,40 39,30		53783	Radbremszylinder Serie 80	126,90 105,80	
90860	Bremsklotz verwendbar anstelle von: 5196712, 5185950 passend zu Steyr CVT 6165, 6170, 6180, 6185, 6200, 6205, 6210, 6215, 6225, 6235	43,90 36,60		63048	Radbremszylinder Original FTE verwendbar anstelle von: 133700340034 passend zu Steyr 8060,8070,8080,8090	239,90 199,90	
90869	Bremsklotz beidseitig verwendbar anstelle von: 5168218 passend zu Steyr Kompakt 360, 370, 375, 485, 495, 4065, 4075, 4085, 4095;	23,90 19,90		53788	Dichtsatz für Radbremszylinder 53783 AD 28 mm	30,90 25,80	
90870	Bremsklotz einseitig verwendbar anstelle von: 5168216 passend zu Steyr Kompakt 360, 370, 375, 485, 495, 4065, 4075, 4085, 4095	23,90 19,90		61657	Hauptbremszylinder verwendbar anstelle von: 4777898, 87315873, 87315873, 87754484 passend zu MXM: 175, 190 PUMA: 165, 170, 180, 185, 195, 200, 210, 215, 220, 225, 230, 240; CVT: 6165, 6170, 6180, 6185, 6200, 6205, 6210, 6215, 6220, 6225, 6230, 6240;	738,00 615,00	
90871	Bremsscheibe AØ 90,5 mm, 8 Zähne, Stärke 4 mm verwendbar anstelle von: 5168219 passend zu Steyr Kompakt 360, 370, 375, 485, 495, 4065, 4075, 4085, 4095	10,90 9,08		53784	Hauptbremszylinder Serie 80 verwendbar anst. von: 135700350013 passend zu 8060, 8070, 8080, 8090	436,90 114,10	
90863	Bremsklotz beidseitig verwendbar anstelle von: 5199788	35,90 29,90		89955	Hauptbremszylinder verwendbar anst. von: 137700357055 passend zu 8110, 8120, 8130, 8140, 8150, 8160, 8165, 8170, 8180	498,90 165,80	
90864	Bremsklotz einseitig verwendbar anstelle von: 5199607	25,90 21,60		89956	Reparatursatz zu Hauptbremszylinder verwendbar anst. von: 137700350707 passend zu 8110,8120,8130,8140, 8150,8160,8165,8170,8180	46,40 38,40	
90865	Außenplatte verwendbar anstelle von: 47127226 passend zu Steyr Profi 4100, 4110, 4115, 4120, 4130, 6115, 6125, 6135, 6140, Profi CVT 6130, 6145, 6160	54,00 42,50		65211	Hauptbremszylinder passend zu Steyr 667, 680	499,00 165,80	
90866	Bremsscheibe AØ = 189 mm, 22 Zähne, Stärke = 4,5 mm verwendbar anstelle von: 47127225 passend zu Steyr Profi 4100, 4110, 4115, 4120, 4130, 6115, 6125, 6135, 6140, Profi CVT 6130, 6145, 6160	30,90 25,80		89957	Radbremszylinder verwendbar anstelle von: 1395340107 passend zu 8110,8120,8130,8140, 8150,8160,8165,8170,8180	269,00 224,20	
90872	Zugfeder-Bremspedal verwendbar anstelle von: 134643097 passend zu Steyr 9078, 9086, 9094, 9105, 9115, 9125, 9145, CVT 120, 130, 150, 170, 6135, 6140, 6145, 6150, 6155, 6160, 6170, 6175, 6190, M 9078, 9080, 9083, 9086, 9090, 9094, 9100, MT 9080, 9085, 9090, 9095, 9100, 9105	15,90 13,30		89958	Reparatursatz zu Radbremszylinder verwendbar anstelle von: E35514-1397350702 passend zu 8110,8120,8130,8140, 8150,8160,8165,8170,8180	57,40 47,60	

Bremse

Nr.	Bezeichnung	€	Nr.	Bezeichnung	€
89960	Hauptbremszylinder verwendbar anstelle von: 133135228 passend zu 9105,9115,9125,9145 und Case IH CS110,CS120, CS130,CS150,120,130,150	164,90 137,40	89962	Radbremszylinder verwendbar anstelle von: 153700340006-47401978 passend zu M948,M958,M952,M963, M968,M975,958,952,963,968,975	95,90 79,90
92403	Radbremszylinder re. verwendbar anstelle von: 155700340050 passend zu M: 9078, 9086, 9094	518,90 432,40	89953	Hauptbremszylinder verwendbar anstelle von: 47132767-84535046 passend zu CVT 6140,6150,6160, 6175, 6195, Profi 4100,4110,4115, 4120,4130,6115,6125,6135,6140	188,90 157,40
92404	Radbremszylinder li. verwendbar anstelle von: 155700340049 passend zu M: 9078, 9086, 9094;	518,90 432,40	89954	Hauptbremszylinder verwendbar anstelle von: 87354670-5177993 passend zu Kompakt 360,370,375, 485,495,4065,4075,4085,4095	168,90 140,80
95317	Betätigungszyylinder rechts Hebellänge = 70 mm verwendbar anstelle von: 155700340041, 134734041	849,00 707,50	80130	Hauptbremszylinder verwendbar anstelle von: 133135418 / 133135155 passend zu CVT 120,130,150,170,6135, 6140,6145,6150,6155,6160,6170,6175, 6190,6195,CVX 120,130,140,150,160, 170,175,195,1145,1155,CVX1170,1190, 1195,CS78,CS80,CS86,CS90,CS94, CS95,CS100,CS110,CS120,CS130, CS150;9078,9080,9083,9086,9094, 9080,9095,9105,9115,9125,9145	478,90 149,10
95318	Betätigungszyylinder links Hebellänge = 70 mm verwendbar anstelle von: 155700340040, 134734040 passend zu CNH-Steyr 9078, 9086, 9094, M: 9078, 9083, 9086, 9094	849,00 707,50	80212	Repsatz zu Hauptbremsz. L = 51,5 mm Ø 19 mm verwendbar anstelle von: 1480350750 passend zu 540A,650A,760A,658A, 780A,980A,1090A,1100A,1200A	80,90 67,40
95319	Betätigungszyylinder rechts Hebellänge = 90 mm verwendbar anstelle von: 155700340027, 131734027	799,00 665,80	80213	Repsatz zu Hauptbremsz. L = 56,5 mm Ø = 31 mm verwendbar anstelle von: 1292350715 passend zu 650 A bis FGN 1954	108,90 90,80
95320	Betätigungszyylinder links Hebellänge = 90 mm verwendbar anstelle von: 155700340026, 131734026 passend zu CNH-Steyr 9078, 9086, 9094, M: 9078, 9083, 9086, 9094	799,00 665,80	80214	Repsatz zu Hauptbremsz. L = 35 mm Ø = 16 mm passend zu 980,1090,1100,1200	65,90 54,90
95321	Betätigungszyylinder re./li. verwendbar anstelle von: 133100340010, 133100340009 passend zu CNH-Steyr 9105, 9115, 9125, 9145	828,90 690,80	90189	Bremsschlauch M12 x 1 L = 350 mm passend zu Steyr	50,40 42,00
89961	Reparatursatz-Radbremszylinder verwendbar anstelle von: 155700340710 passend zu 9078,9086,9094,M9078, M9083,M9086,M9094,9105, 9115,9125,9145	99,90 83,30	90190	Bremsschlauch M12 x 1 L = 480 mm passend zu Steyr	52,40 43,70
89950	Hauptbremszylinder verwendbar anstelle von: 133135417 passend zu M948,M958, M952,M963,M968,M975, 958,952,963,968,975	479,00 149,20	64672	Radbremszylinder verwendbar anstelle von: T5281, V30181500, V30181510 passend zu Steyr 667, 680;	58,90 49,10
97275	Reparatursatz-Hauptbremszyl. Kolben Ø 7/8" verwendbar anstelle von: 1288228C1, 133735020 passend zu Steyr: 9078, 9086, 9094, 9105, 9115, 9125, 9145 CVT: 120, 130, 150, 170, 6135, 6140, 6145, 6150, 6155, 6160, 6170, 6175, 6190, 6195, M: 9078, 9080,9083, 9086, 9090,9094, 9100, MT: 9080, 9085, 9090, 9095, 9100, 9105	28,90 24,10	Hohlkieten		
			78178	Hohlkiete Cu 3 x 8 100 Stk.	14,90 12,40
			53782	Hohlkiete Cu 4 x 10 100 Stk.	18,90 15,80
			53558	Hohlkiete Cu 5 x 12 100 Stk.	18,90 15,80
			74528	Hohlkiete Cu 5 x 15 100 Stk.	32,90 27,40
			74526	Hohlkiete Cu 6 x 12 100 Stk.	32,90 27,40
			91702	Hohlkiete Cu 8 x 18 100 Stk.	52,90 44,10

Ersatzteile zu Handbremse

Nr.	Bezeichnung	€
61625	Abdeckung zu Gaspedal verwendbar anstelle von: 5167651, 84250071	15,90 13,30
54376	Feder verwendbar anstelle von: 288340042 passend zu Steyr 430,540,650,760, 8055,8075,8065,8085,943,948,955, 964,970	3,80 3,20
90191	Büchse verwendbar anstelle von: 1295340026 passend zu Steyr Serie Plus	22,90 19,10
54377	Segment zu Bremshebel verwendbar anstelle von: 292350120, 288350120 passend zu Steyr 540, 545, 650, 658, 760, 768, 8055, 8073, 8075, 8085, 8095, Steyr Plus, T180A	24,90 20,80
54338	Segment zu Kupplungshebel verwendbar anstelle von: 33700270242 passend zu Steyr Serie Plus	28,90 24,10
95884	Handbremsklinke verwendbar anstelle von: 1288350017, 1390350055 passend zu Steyr Plus	9,90 8,30
74800	Knopf für Handbremse Ø 18 mm, Gewinde M5	16,90 14,10
74801	Feder für Handbremsstange	5,90 4,90
74802	Handbremsstange passend zu Steyr T80,T84,T86	79,90 66,60
74803	Handbremszahn zum Einschweißen in 74802	12,90 10,80
74804	Handbremsraste passend zu Steyr T80/T84/T86 (15,18)	49,90 41,60
74805	Handbremsraste passend zu Steyr T180/182/185/290	25,90 21,60
74806	Handbremsraste passend zu Steyr N180a	38,90 32,40
74807	Handbremsklinke passend zu Steyr N180A	11,90 9,90
74808	Handbremsklinke passend zu Steyr T188	15,90 13,30



Nr.	Bezeichnung	€
74809	Handbremsraste passend zu Steyr T188	21,90 18,30
61203	Sperrklinke für Kupplungshandhebel verwendbar anst. von: 390350055 passend zu Steyr 540, 545, 650, 658, 760, 768	10,90 9,10
93682	Kupplungshandhebel zu Doppelkupplung verwendbar anstelle von: 295270019, 28800240030 passend zu Steyr	104,90 87,40
93683	Kupplungshandhebel zu Lamellenkupplung verwendbar anstelle von: 29270099 passend zu Steyr 540, 545, 650, 658, 760, 768	104,90 87,40
62604	Konsole verwendbar anstelle von: 292230056 passend zu Steyr Plus: 650, 658, 760, 768	34,90 29,10
62605	Büchse ID = 19,6 mm verwendbar anstelle von: 292230061 passend zu Steyr Plus: 650, 658, 760, 768	6,90 5,80



Achsschenkel

Nr.	Bezeichnung	€
93685	Achsschenkel re./li. passend zu Steyr T80, 84, 86	198,90 165,80
80660	Achsschenkelbüchse 30 x 35 x 30 mm passend zu Steyr T80	19,50 16,30
60487	Anlaufscheibe oben 4 mm passend zu Steyr T: 80, 84, 86	18,90 15,80
60486	Anlaufscheibe unten 6 mm passend zu Steyr T: 80, 84, 86	27,90 23,30
61645	Labyrinthblech verwendbar anstelle von: 804118 passend zu Steyr T80	23,90 19,90
64812	Keilbolzen verwendbar anstelle von: 1804124, 180410024 passend zu Steyr T80, T84, T86, 188, 288	36,90 30,80



Achsschenkel

Nr.	Bezeichnung	€
54358	Achsschenkel rechts verwendbar anstelle von: 292 41 0078	131,90 109,90
54359	Achsschenkel links A=295 mm B=35 mm D=40 mm D1=30 mm G=M20x1,5 verwendbar anstelle von: 292 41 0077 passend zu 650,760,768	131,90 109,90

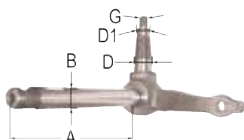

60789	Achsschenkel rechts verwendbar anstelle von: 133700410247, 33700410198, 33741247	268,90 224,10
-------	--	------------------------------------



60790	Achsschenkel links A=257 mm B=40 mm D=38 mm D1=29 mm G=M24 verwendbar anstelle von: 133700410245, 33700410184, 33741184 passend zu Steyr 900, 8055, 8060, 8065, 8070, 8075, 8080, 8090	268,90 224,10
-------	--	------------------------------------



Nr.	Bezeichnung	€
60796	Muffe verwendbar anstelle von: 133700290258 passend zu 942, 948, 955, 964, 970, 8045, 8055, 8060, 8065, 8070, 8075, 8080, 8090, 9078, 9086, 9094 M: 948, 952, 958, 963, 968, 975, 9078, 9080, 9083, 9086, 9090, 9094, 9100 MT: 9080, 9085, 9090, 9095, 9100, 9105	84,90 70,80



60797	Flanschlager verwendbar anstelle von: 133131035 passend zu 942, 948, 955, 964, 970, 8045, 8055, 8060, 8065, 8070, 8075, 8080, 8090, 9078, 9086, 9094 M: 948, 952, 958, 963, 968, 975, 9078, 9080, 9083, 9086, 9090, 9094, 9100 MT: 9080, 9085, 9090, 9095, 9100, 9105	226,90 189,10
-------	--	------------------------------------



Lager für Allradachsen

63721	Lager 18 x 52 x 16 mm verwendbar anstelle von: 87523063, 137700410834, N14373, K395040, 3523057M1, 9968002 passend zu 9105, 9115, 9125, 9145 CVT: 102, 130, 150, 6135 6140, 6145, 6150, 6155, 6160 Multi: 4095, 4105, 4115	18,70 15,60
-------	--	----------------------------------



63727	Flanschlager 30 x 62 x 30 mm Lochabstand: 90 mm verwendbar anstelle von: 5167098 passend zu Kompakt: 360, 370, 375, 495, 4085	26,90 22,40
-------	---	----------------------------------



Teile passend zu Serie Plus

54361	Büchse zu Achsschenkel verwendbar anstelle von: 1188410101, 1192410138	12,90 10,80
-------	--	----------------------------------



90895	Büchse zu Achsschenkel verwendbar anstelle von: 133700410213 passend zu Steyr 9083 M, M 9083, 948, 952, 958, 963, 968, 975, 9078, 9086, 9094;	12,90 10,80
-------	--	----------------------------------



54362	Konusbolzen verwendbar anstelle von: 280 41 0027	11,90 9,90
-------	--	---------------------------------



54363	Lenkhebel zu Steyr Serie Plus verwendbar anstelle von: 292410068	58,90 49,10
-------	--	----------------------------------



54360	Befestigung rechts zu Achsschenkel passend zu Steyr Plus Serie	61,90 51,60
-------	---	----------------------------------



54364	Radflansch verwendbar anstelle von: 288410131	77,10 64,30
-------	---	----------------------------------



54365	Abdeckung für Radflansch verwendbar anstelle von: 288410146	6,90 5,80
-------	---	--------------------------------



54367	Kappe verwendbar anstelle von: 288 41 0147	11,50 9,60
-------	--	---------------------------------



54366	Ring verwendbar anstelle von: 288410145	13,50 11,30
-------	---	----------------------------------



60791	O-Ring oben 54 x 5,5 mm verwendbar anstelle von: 1800410049	2,20 1,80
-------	---	--------------------------------



60792	O-Ring unten 49 x 5,5 mm verwendbar anstelle von: 288410166	2,20 1,80
-------	---	--------------------------------



60920	Unterlagscheibe 35,5 x 64 x 4 mm verwendbar anstelle von: 288410205	12,90 10,80
-------	---	----------------------------------



60921	Unterlagscheibe 40,5 x 64 x 4 mm verwendbar anstelle von: 295410060 passend zu Plus Serie 80, 900	13,90 11,60
-------	--	----------------------------------



54368	Radbolzen vorne verwendbar anstelle von: 1800410034	7,20 6,00
-------	--	--------------------------------



54369	Radmutter M14x1,5 verwendbar anstelle von: 90003884514	6,60 5,50
-------	---	--------------------------------



54370	Sicherung zu Steyr Serie Plus verwendbar anstelle von: 190 41 0031	3,50 2,90
-------	--	--------------------------------



96967	Mittelachsbolzen verwendbar anstelle von: 1192410011	54,90 45,80
-------	---	----------------------------------

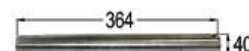

90895	Büchse 40 x 45 x 55 mm verwendbar anstelle von: 133700410213 passend zu Steyr 9083 M, M 9083, 948, 952, 958, 963, 968, 975, 9078, 9086, 9094;	12,90 10,80
-------	---	----------------------------------



Nr.	Bezeichnung	€
60793	Anlaufscheibe 40 x 62 x 3 mm verwendbar anstelle von: 192410037	4,10 3,40
60794	Anlaufscheibe 40 x 62 x 3,5 mm verwendbar anstelle von: 192410038	4,10 3,40
60795	Anlaufscheibe 40 x 62 x 4 mm verwendbar anstelle von: 192410039	4,10 3,40



97972	Lagerbock verwendbar anstelle von: 31700410004 passend zu Steyr 942, 948, 8045	165,90 138,30
-------	--	------------------



Lenkräder

Nr.	Bezeichnung	€
80186	Lenkrad Ø = 380 mm H = 115 mm passend zu Steyr Serie 80,900,9000	74,90 62,40



54379	Lenkrad Ø = 450 mm H = 160 mm mit Verzahnung verwendbar anstelle von: 92470018 passend zu Steyr Plus	39,90 33,30
-------	---	----------------



54380	Kappe zu Lenkrad, Ø = 60,5 mm verwendbar anstelle von: 92470019 passend zu Steyr	3,90 3,30
-------	--	--------------



54204	Lenkrad Ø = 425 mm Höhe = 72 mm passend zu Steyr T80/T84,15/18,T188	48,90 40,80
-------	--	----------------



87666	Lenkrad verwendbar anstelle von: 1804744 passend zu Steyr Jubiläumsserie: T: 86, 188, 190, 288, 290	94,90 79,10
-------	--	----------------



74810	Lenkradabdeckung in Chrom zu 54204	12,50 10,40
-------	--	----------------



74811	Hupendeckel für Lenkrad Ø 50 mm, 1 Anschluss	16,90 14,10
-------	---	----------------



00368	Univ. Lenkergriff Standard	6,50 5,40
-------	-------------------------------	--------------



Nr.	Bezeichnung	€
64835	Welle verwendbar anstelle von: 5191412 passend zu Kompakt: 485, 495, 360, 370, 375, 4055S, 4065, 4065S, 4075, 4085, 4095	159,00 132,50



64559	Bolzen Ø = 25 mm, L = 91 mm verwendbar anstelle von: 5171707 passend zu CVT: 6130, 6145, 6145, 6160, 6165, 6170, 6180, 6185, 6200, 6205, 6210, 6215, 6225, 6230 Profi Tier 3: 6115, 6125, 6140	28,90 24,10
-------	---	----------------



zu Kugelgelenke

Dichtmanschetten für Kugel- und Axialgelenke

Nr.	Bezeichnung	€
54435	Staubschutz D=10 D1=25	15,90 13,30
54436	Staubschutz D=12 D1=28	6,00 5,00
54437	Staubschutz D=10 D1=37	6,00 5,00
54438	Staubschutz D=15 D1=37	6,00 5,00
54430	Staubschutz D=16 D1=40	6,00 5,00
54256	Staubschutz D=19 D1=44	6,00 5,00
54257	Staubschutz D=28 D1=56	6,00 5,00
54258	Staubschutz D=20 D1=56	6,30 5,30
54441	Staubschutz D=15 D1=37	25,90 21,60
54431	Staubschutz D=19 D1=44	37,90 31,60
54432	Staubschutz D=24 D1=44	25,90 21,60
54433	Staubschutz D=24 D1=50	31,90 26,60
54434	Staubschutz D=27 D1=50	39,90 33,30



Nr.	Bezeichnung D / D1 / H	€
54261	Staubschutz 12/30/15	5,90 4,90
97569	Staubschutz 12/35/14	5,90 4,90
54262	Staubschutz 16/40/16	5,90 4,90
97570	Staubschutz 14/40/18	6,90 5,80
97571	Staubschutz 19/47/22	8,90 7,40
64569	Staubschutz 12/49/25	8,90 7,40
64570	Staubschutz 19/48/25	8,90 7,40



Kugelgelenke

AG = Außengewinde, IG = Innengewinde, R = Rechtsgewinde, L = Linksgewinde

52643	Kugelgelenk verwendbar anstelle von: 188430702 passend zu 30,430,40,540	33,00 27,50
-------	---	----------------



62978	Kugelgelenk verwendbar anstelle von: 188430702 passend zu 30,430,40,540	33,00 27,50
-------	---	----------------



52646	Kugelgelenk verwendbar anstelle von: 397470192 passend zu 545,548,760, 8045,8140,8150,8160	58,90 49,10
-------	---	----------------



Kugelgelenke

AG = Außengewinde, IG = Innengewinde, R = Rechtsgewinde, L = Linksgewinde

Nr. Bezeichnung €
 52649 Kugelgelenk 44,90
 verwendbar anstelle von: 37,40
 397470008
 passend zu T180, T190, T288



52641 Kugelgelenk 32,90
 verwendbar anstelle von: 292430718 27,40
 passend zu 40,50,540,548,
 650,6587,760,768



52652 Kugelgelenk 30,90
 verwendbar anstelle von: 192430733 25,80
 passend zu 40,540,50,
 650,760,658,768



54496 Kugelgelenk links 48,90
 verwendbar anstelle von: 133741674 40,80
 passend zu M948,952,958,963



52655 Kugelgelenk 28,90
 verwendbar anstelle von: 192430735/ 192470126 24,10
 passend zu 430,540,545,
 650,760,768



52658 Kugelgelenk 28,90
 verwendbar anstelle von: 192430741/ 192470120 24,10
 passend zu 30,430,40,540,
 548,50,650,760,768



52661 Kugelgelenk 33,90
 verwendbar anstelle von: 192430710 28,30
 passend zu 40,548,650,658,
 768,988,1108



52664 Kugelgelenk 33,30
 verwendbar anstelle von: 192430755 27,80
 passend zu 40,548,650,658,
 768,988,1108



54410 Kugelgelenk re. 29,90
 verwendbar anstelle von: 5117314 24,90
 passend zu Kompakt: 360, 370, 375,
 Profi: 4100, 4115, 6115, 6125;



52666 Kugelgelenk 39,90
 verwendbar anstelle von: 292430738 33,30
 passend zu 50,650,658,760,768



52668 Kugelgelenk 94,70
 verwendbar anstelle von: 35700431008 78,90
 passend zu 8070,8080,8090

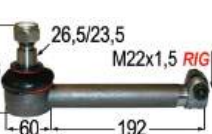

54400 Kugelgelenk 93,90
 verwendbar anstelle von: 33743010 77,50
 passend zu 955,964,970, M948,
 M958,M952,M963,M968,M975



Nr. Bezeichnung €
 54401 Kugelgelenk 96,90
 verwendbar anstelle von: 80,80
 35700431003
 passend zu 8060,8065,8070,
 8075,8080,8085,8090



54396 Kugelgelenk 136,90
 verwendbar anstelle von: 135700431006 114,10
 passend zu 8060,
 8070,8080,8090



94541 Spurstangengelenk 110,90
 passend zu Steyr 92,40
 8060,8065,8070,8075,8080,8090,
 8100,8110,8120,8130,8140,8160



54402 Kugelgelenk 79,90
 verwendbar anstelle von: 33743603 65,80
 passend zu 9078,9086,9094,
 M968,M975



51546 Kugelgelenk + Axialgelenk 138,50
 verwendbar anstelle von: 354716A1 115,40
 passend zu Steyr
 9078, 9086, 9094,
 M: 968, 975;



54403 Kugelgelenk 75,90
 verwendbar anstelle von: 33743601 63,30
 passend zu 9078, 9086, 9094



54246 Kugelgelenk re. 86,90
 verwendbar anstelle von: 133743305, 133743306,
 135700430707, 133743301 72,40
 passend zu M968,M975, 8060, 8065,
 8070, 8075, 8080, 8085, 8090,



96270 Spurstangengelenk re. 98,20
 verwendbar anstelle von: 133700430704, 133700430706,
 133700430722, 133700430723,
 133700430725 81,80
 passend zu M900ER,
 M9000ER Serie



54426 Kugelgelenk 63,80
 verwendbar anstelle von: 133741674 53,20
 passend zu M948,
 M958,M952,M963



54428 Kugelgelenk 83,90
 verwendbar anstelle von: 133743002 69,90
 passend zu M: 948, 952, 958, 963,
 964, 968, 970, 975;



54411 Kugelgelenk 132,90
 verwendbar anstelle von: 1397470179 110,80
 passend zu 942,948,955,964,970,
 M948,M958,M952,M963,M968,
 M975,9078,9086,9094,M9078,
 M9083,M9086,M9094



Kugelgelenke

AG = Außengewinde, IG = Innengewinde, R = Rechtsgewinde, L = Linksgewinde

Nr. Bezeichnung €
 51547 Kugelgelenk + Axialgelenk 149,99
 verwendbar anstelle von: **124,90**

133743621
 passend zu Steyr 9105, 9115, 9125, 9145, CVT: 120, 130, 150, 6135, 6140, 6145, 6150, 6155, 6160;



54247 Kugelgelenk 89,80
 verwendbar anstelle von: **74,80**
 1277261C1
 passend zu Magnum 9200,9220,9250,9270



54248 Kugelgelenk re. 66,99
 verwendbar anstelle von: 1277451C1 **55,80**

54249 Kugelgelenk li. 66,99
 verwendbar anstelle von: 1277452C1 **55,80**
 passend zu Magnum 9200,9220, 9250,9270



54596 Kugelgelenk re. 97,50
 verwendbar anstelle von: 128604A1 **81,30**

54597 Kugelgelenk li. 97,50
 verwendbar anstelle von: 128604A1 **81,30**
 passend zu Magnum 9200,9220,9250,9270



54586 Kugelgelenk re. für Spurstange 99,60
 verwendbar anstelle von: 1-33-743-617 **83,00**

54587 Kugelgelenk li. für Spurstange 99,60
 verwendbar anstelle von: 1-33-743-619 **83,00**
 passend zu Steyr 9105,9115,9125,9145 CS100,110,120,130,150



54588 Kugelgelenk li. 83,99
 für Spurstange **69,90**
 verwendbar anstelle von: 247523A1/ 340483A1
 passend zu Steyr 9105,9115, 9125,9145



54589 Kugelgelenk li. u. re. 404,40
 gerade, für Spurstange, starre Achse **84,30**
 verwendbar anstelle von: 411904A1



97070 Kugelgelenk 66,99
 verwendbar anstelle von: 5198880 **55,80**
 passend zu Steyr CVT: 6165, 6180, 6200, 6210, 6225



97073 Kugelgelenk 60,99
 verwendbar anstelle von: **50,80**
 5198880, 87714473
 passend zu Steyr CVT: 6165, 6180, 6200, 6210, 6225



97072 Kugelgelenk 408,99
 verwendbar anstelle von: **90,80**
 166700430707, 31952500
 passend zu Steyr Kompakt:360, 370, 375, 485, 495, 4065, 4075, 4085, 4095



Nr. Bezeichnung €
 60605 Kugelgelenk + Axialgelenk 158,90
 verwendbar anstelle von: **132,40**
 87395856, 47125373
 passend zu Steyr 360, 370, 375, 485, 495, 4065, 4075, 4085, 4095

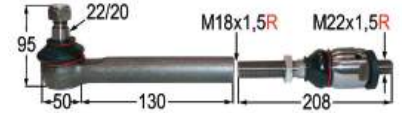

54372 Spurstange kpl. 154,99
 verwendbar anstelle von: 292430069 **129,10**
 passend zu Serie Plus, kpl. L = 1090 mm



54373 Lenkstange kpl. 159,99
 verwendbar anstelle von: 292430107 **133,30**
 passend zu Serie Plus, kpl. L = 1215 mm



78179 Kugelgelenk re. 29,60
24,70



78180 Kugelgelenk li. 27,90
23,30



80941 Kugelgelenk zu 54734 56,99
 passend zu **47,40**
 Hydrolenkungssatz 54734



52682 Axialgelenk 74,40
 verwendbar anstelle von: 35700431009 **59,50**
 passend zu 8060,8075,8070,8080, 8090,8100,8120,8130

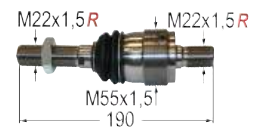

54404 Axialgelenk 59,50
 verwendbar anstelle von: 35700431012 **49,60**
 passend zu 8055,942,948,958,952,963, 968,975,9078,9083,9086,9094



54405 Axialgelenk 68,99
 verwendbar anstelle von: 33743011 **57,40**
 passend zu 948,955,958,952, 964,968,975



60604 Axialgelenk 99,99
 verwendbar anstelle von: 87395856 **83,30**
 passend zu Steyr 360, 370, 375, 485, 495, 4065, 4075, 4085, 4095



54585 Axialgelenk 78,30
 verwendbar anstelle von: 133743613 **65,30**
 passend zu Steyr 6135,6140, 6145,6150,6155,6160,9105,9115 9125,9145, CVT120,130,150



63435 Axialgelenk 98,99
 verwendbar anstelle von: 133741717 **82,40**
 passend zu 9105, 9115, 9125, 9145 CVT: 170, 6135, 6140, 6145, 6155, 6160, 6170, 6175, 6190, 6195



52685 Kugelaugue 58,99
 verwendbar anstelle von: 37700470144 **49,10**
 passend zu 8055,8060,8075,8070, 8080,8090,8100,8120,942,948,955, 964,970,975,9078,9086,9094



Nr. Bezeichnung €
 94333 Gelenklager GE25FO 2RS 19,90
 verwendbar anstelle von: 16,60
 133700470767, 137700470082



54414 Kugelaugue 103,80
 verwendbar anstelle von: 37700470110 86,50
 passend zu 8060,8070,8080,
 8090,8100,8120



Kugelbolzensätze

Nr. Bezeichnung €
 52671 Kugelbolzensatz 34,90
 L = 53, G = M10, D = 20, 27,90
 K/K1 = 12,50/14,50
 verwendbar anstelle von: 80430999
 passend zu 80,80A,84,84A,84E,84S,188

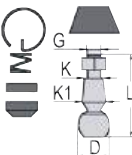

52674 Kugelbolzensatz 37,90
 L = 68, G = M14, D = 24, K/K1 = 16 /18 31,60
 verwendbar anstelle von: 6090601
 passend zu 180



52677 Kugelbolzensatz 45,90
 L = 80, G = M16, D = 30, K/K1 = 18 /20 38,30
 verwendbar anstelle von: 1700430010
 passend zu 185,185A,280,280A

Kotflügel



Nr.	Bezeichnung	L mm	B mm	Radius	€
12371	Kotflügel	1000	265	615	36,90 30,80
zu Bereifung: 9.5-24+28, 8.3-28, 10.5-18					
12372	Kotflügel	1080	320	660	36,90 30,80
zu Bereifung: 1.2-24+28, 10.5-20					
12373	Kotflügel	1100	360	660	38,90 32,40
zu Bereifung: 12.4-24, 13.6-24, 12.5-18+20					
51774	Kotflügel	1300	380	720	36,90 30,80
zu Bereifung: 12.45-28, 13.6-28, 14.6-24+26					
12376	Kotflügel	1325	420	720	37,90 31,60
zu Bereifung: 13.6-28					
12377	Kotflügel	1330	480	780	42,90 35,80
zu Bereifung: 16.9-24+26, 18.4/70-28					
51775	Kotflügel	1500	540	800	49,90 41,60
61035	Kotflügel	1560	620	810	53,90 44,90
51776	Kotflügel	1900	620	900	59,90 49,90

Nr. Bezeichnung €
 52638 Universal-Kotflügelhalterung 7,90
 verstellbar 6,60



87663 Universal-Kotflügel 63,90
 vorne re./li. 53,30
 für Oldtimer



Abstellseilzüge

Nr. Bezeichnung €
 86373 Abstellseilzug 28,90
 L = 885 mm 24,10
 verwendbar anstelle von: 133700570111
 passend zu 8055



77868 Abstellseilzug 27,90
 L = 1090/933 mm 23,30
 verwendbar anstelle von: 133700570085
 passend zu 8065,8075,8085,8095



86372 Abstellseilzug 27,90
 L = 1510 mm 23,30
 verwendbar anstelle von:
 1397570083, 139570701
 passend zu 8140,8150,8165,8170,8180



86374 Seilzug Motorhaube 27,90
 L = 730 mm 23,30
 verwendbar anstelle von: 133700570155
 passend zu 955,964,970



Seilzüge

Nr. Bezeichnung €
 53048 Kupplungsseilzug 76,90
 L = 960 mm, M10 x 1,5, Ø 10 mm, 64,10
 Seilhülle M18 x 1,5
 verwendbar anstelle von: 134143015
 passend zu 8070,8080,8090



53049 Kupplungsseilzug 78,90
 L = 980 mm, M10 x 1,5, Ø 10 mm, 65,80
 Seilhülle M18 x 1,5
 verwendbar anstelle von: 134143016
 passend zu 8100,8110,8120,8130



86389 Seilzug Kupplung 69,90
 L = 756mm 58,30
 verwendbar anstelle von: 134543580
 passend zu 948,952,958,963
 Case CS48,52,58,63



86390 Seilzug Kupplung 75,90
 L = 745 mm 63,30
 verwendbar anstelle von: 134543558
 passend zu 968,975



87598 Seilzug Kupplung 75,20
 L = 1020 mm, M10 62,70
 verwendbar anstelle von: 134643170
 passend zu 9078, 9083,
 9086, 9094, CS78, CS86, CS94



90885 Kupplungsseilzug 49,90
 L = 549 mm 41,60
 Hüllenslänge = 290 mm
 verwendbar anstelle von: 5174885
 passend zu Kompakt 360, 370, 375,
 485, 495, 4065, 4075, 4085, 4095;



77869 Gasseilzug 27,90
 L = 740 mm 23,30
 verwendbar anstelle von: 134543236
 passend zu 948,952,958,963,968,975



86370 Seilzug Handgas 34,50
 L = 3365 mm 28,80
 verwendbar anstelle von: 134643425
 passend zu 9078,9086,9094



Seilzüge

Nr.	Bezeichnung	€		Nr.	Bezeichnung	€	
86365	Seilzug Handgas L= 1660 mm verwendbar anstelle von: 134643535 passend zu 9115,9125,9145, Case: CS120,130,150	34,90 29,10		62257	Handbremsseil re. L = 1150 mm verwendbar anstelle von: 134443081	77,90 64,90	
86371	Seilzug Handgas L= 2800 mm verwendbar anstelle von: 134643081 passend zu 9078,9083,9086,9094 Case: CS78,86,94	31,90 26,60		62258	Handbremsseil li. L = 725 mm verwendbar anstelle von: 134443083 passend zu 8060	74,50 62,10	
86367	Seilzug Fußgas L= 1160 mm verwendbar anstelle von: 134643531 passend zu 9078,9083,9086,9094	19,50 16,30		86379	Seilzug Handbremse re. L = 1120 mm verwendbar anstelle von: 134443101 passend zu 8060,8070	70,90 59,10	
86368	Seilzug Fußgas L= 385mm verwendbar anstelle von: 134643098 passend zu 9078,9083,9086,9094	16,40 13,70		86380	Seilzug Handbremse li. L = 575 mm verwendbar anstelle von: 134443102 passend zu 8060,8070	70,90 59,10	
86369	Seilzug Fußgas L= 775 mm verwendbar anstelle von: 134543628 passend zu 968,975	23,90 19,90		86382	Seilzug Handbremse re. L = 1250 mm verwendbar anstelle von: 134443085 passend zu 8060,8070,8080,8090	72,90 60,80	
86366	Seilzug Fußgas L= 1065 mm verwendbar anstelle von: 134543230 passend zu 968,975	25,90 21,60		86383	Seilzug Handbremse li. L= 785 mm verwendbar anstelle von: 134443087 passend zu 8060,8070,8080,8090	70,90 59,10	
77870	Gasseilzug L = 373 mm verwendbar anstelle von: 134643098 passend zu 9078,9086,9094	16,50 13,80		86384	Seilzug Handbremse li. L = 918 mm verwendbar anstelle von: 133700350155 passend zu 8065,8075,8085,8095	72,90 60,80	
77871	Gasseilzug L = 1170 mm verwendbar anstelle von: 134643531 / 134643424 passend zu 9078,9086, 9094,9105,9115,9125,9145	20,90 17,40		86385	Seilzug Handbremse re. L = 1395 mm verwendbar anstelle von: 133700350154 passend zu 8065,8075,8085,8095	72,90 60,80	
77872	Gasseilzug L = 3400 mm verwendbar anstelle von: 134643425 passend zu M 9078,9086, 9094,9105,9115,9125,9145	35,90 29,90		86375	Seilzug Allradb. L = 1860 mm verwendbar anstelle von: 134544035 passend zu 8060,8070,8080,8090	73,90 61,60	
86386	Seilzug Handbremse re. L = 1025 mm verwendbar anstelle von: 134443103 passend zu 8080,8090	69,90 58,30		86376	Seilzug Allradb. L = 885 mm verwendbar anstelle von: 134544017 passend zu 8060,8070,8080,8090	67,90 56,60	
86387	Seilzug Handbremse li. L = 695 mm verwendbar anstelle von: 134443104 passend zu 8080, 8090	69,90 58,30		86381	Seilzug Zapfwellenk. L = 882 mm verwendbar anstelle von: 134344062 passend zu 8060,8070,8080,8090	75,10 62,60	
86388	Seilzug Handbremse L = 520 mm verwendbar anstelle von: 133135090 passend zu 948,952,955,958, 963,964,970	38,90 31,70		86377	Seilzug Fernbetätigung Hydraulik L = 1008 mm verwendbar anstelle von: 134744012 passend zu 948,952,955,958,963, 964,968,970,975	89,50 74,60	
				77875	Kupplungsseil für Fahr- und Zapfwellenkupplung L = 1150 mm verwendbar anstelle von: 134643170 / 13464393 / 134643139 passend zu 9078,9086,9094	69,90 58,30	
				77873	Handbremsseil re. L = 1620 mm, Gewinde M10 verwendbar anstelle von: 134643061 passend zu 9078,M9078,9080, M9080,9086,M9086,9090, M9090,9094,M9094,M9100	49,90 41,60	

Seilzüge

Nr.	Bezeichnung	€
77874	Handbremsseil li. L = 665 mm, Gewinde M10 verwendbar anstelle von: 134643062 passend zu 9078, M9078, 9080, M9080, 9086, M9086, 9090, M9090, 9094, M9094, M9100	44,90 37,40
89984	Handbremsseil L = 1565 mm verwendbar anstelle von: 84266677 / 5089098	33,90 28,30
89985	Handbremsseil L = 460 mm verwendbar anstelle von: 134643481 passend zu 9105, 9115, 9125, 9145	68,90 57,40
89986	Handbremsseil L = 1030 mm verwendbar anstelle von: 82027734 passend zu: Profi 4100, 4110, 4115, 4120, 4130, 6115, 6125, 6135, 6140	98,90 82,40
89987	Handbremsseil verwendbar anstelle von: 134643509 passend zu: CVT 120, 130, 150, 170, 6135, 6145, 6155, 6170, 6190, 6195	99,90 82,50
90886	Seilzug-Zapfwelle verwendbar anstelle von: 47123120 passend zu Kompakt 360, 370, 375, 485, 495, 4065, 4075, 4085, 4095;	60,90 50,80



Schaltgummi

Nr.	Bezeichnung	€
54345	Dichtgummi zu Schalthebel verwendbar anstelle von: 290240012 passend zu Serie Plus	3,20 2,70
74815	Schaltgummi passend zu T80/84/86/180	11,80 9,80



Schalthebel

Nr.	Bezeichnung	€
54339	Schalthebel re. verwendbar anstelle von: 292240143 passend zu Serie Plus	18,90 15,80
54340	Schalthebel li. verwendbar anstelle von: 337 00 24 0077 passend zu Serie Plus	18,90 15,80
54341	Schalthebel re. verwendbar anstelle von: 292 24 0142 passend zu Serie Plus	20,90 17,40
54342	Schalthebel li. verwendbar anstelle von: 337 00 24 0095 passend zu Serie Plus	15,90 13,30

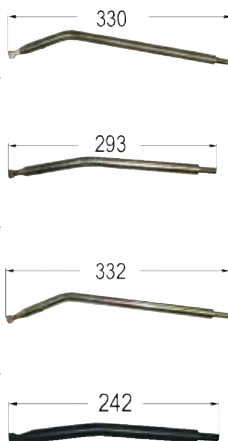

Nr.	Bezeichnung	€
54348	Führung für Schalthebel	11,90 9,90
54351	Schaltschleuse verwendbar anstelle von: 190240005 passend zu Plus	17,90 14,90
54350	Feder zu Schalthebel verwendbar anstelle von: 188240015 passend zu Plus	3,90 3,30
54244	Kugel zu Schaltung passend zu Plus	4,90 4,10
54346	Haltering verwendbar anstelle von: 609050039	3,90 3,30
60922	Kolben für Hydraulik verwendbar anstelle von: 288730060	62,90 52,40
54355	Dichtung verwendbar anstelle von: 288 73 0102 passend zu Serie Plus	12,90 10,80



60802	Anlenkbock verwendbar anstelle von: 292730051 passend zu 30, 40, 50, 430, 540, 545, 548, 650, 658, 760, 768, 942, 948, 955, 964, 970, 8045, 8055, 8060, 8065, 8070, 8075, 8080, 8085, 8090, T: 188, 190	114,90 95,80
60803	O-Ring f. Oberlenkerregelung 26 x 3 mm verwendbar anstelle von: 288730104	3,50 2,90



Schaltgriffe

Nr.	Bezeichnung	€
54343	Schaltgriff verwendbar anstelle von: 188240016 passend zu Serie Plus	7,90 6,60
54344	Schaltgriff verwendbar anstelle von: 292240116 passend zu Serie Plus	8,30 6,90







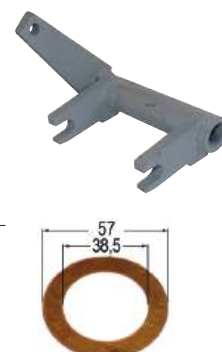





















Diverse Ersatzteile

Nr.	Bezeichnung	€
60919	Hebel für Zapfwellenkupplung verwendbar anstelle von: 292270044 passend zu 942, 948, 955, 964, 970, 9078, 9080, 9085, 9086, 9090, 9090, 9094, 9095, 9100, 9105, M: 9078, 9083, 9086, 9094	61,80 51,50
54352	Anlaufscheibe verwendbar anstelle von: 290 32 0003	20,90 17,40



Diverses Zubehör

Nr.	Bezeichnung	€		Nr.	Bezeichnung	€	
54353	Nadellager verwendbar anstelle von: 188290046	29,90 24,90		95883	Batteriedeckel Außen 330 x 188 mm verwendbar anstelle von: 1292760007 passend zu Steyr Plus	16,90 14,10	
54354	Zahnrad z. Planetenantrieb verwendbar anstelle von: 290 32 0002 passend zu Serie Plus	66,90 55,80		56615	Feder für Hydraulik verwendbar anstelle von: 292730201 passend zu Steyr Plus	3,60 3,00	
54355	Dichtung verwendbar anstelle von: 288 73 0102 passend zu Serie Plus	12,90 10,80		74816	Sitzgummi passend zu Steyr T80/84/86/180	27,90 22,50	
63620	Nutring zu Hubkolben 55 x 75 x 10 mm verwendbar anst. von: 133700730062, 1188730154 passend zu Steyr 188, 190, 430, 540, 8045, 8055, 8060	26,90 22,40		74817	Spiegelstange 10/12 mm passend zu Steyr T80/84/86	15,90 13,30	
77878	Büchse 55 x 65 x 39 mm verwendbar anstelle von: 288730360	9,90 8,30		84591	Spiegelhalter passend zu Steyr T80/84/86/185/280	28,90 24,10	
77879	Büchse 55 x 65,5 x 40 mm verwendbar anstelle von: 288730007	5,90 4,20		64505	Sicherungsblech verwendbar anstelle von: 1113A080009E passend zu Steyr T80, T84, T86, 180a, 182	12,90 10,80	
77880	Dichtring 55 x 69 x 2 mm verwendbar anstelle von: 288730005	4,30 3,60		64506	Mutter Regelgestänge verwendbar anstelle von: 1213F050002E passend zu Steyr T80, T84, T86, 180a, 182	78,90 65,80	
77881	Büchse f. Hubwelle 50 x 58 x 45 mm verwendbar anstelle von: 153700733014	37,90 31,60		64507	Einstellhülse Regelgestänge verwendbar anstelle von: 1113A080008E passend zu Steyr T80, T84, T86, 180a, 182	78,90 65,80	
77850	Büchse 55 x 65 x 40 verwendbar anstelle von: 135700733008 passend zu Serie Plus	37,90 31,60		64508	Verstellstange verwendbar anstelle von: 1113A0500 passend zu Steyr T80, T84, T86, 180, 180a, N180	42,90 35,80	
63328	Nabe ID = 60/110 mm, AD = 138 mm 8 Zähne, Höhe = 18 mm verwendbar anstelle von: 140800160709 passend zu Plus Serie	58,90 49,10		64509	Regelfeder verwendbar anstelle von: 12130050081N passend zu Steyr T80, T84, T86, 180, 180a, 182	23,90 19,20	
63211	Kabelbaum passend zu Steyr T180a	178,90 149,10		96046	Feder-Dekompressorwelle verwendbar anstelle von: 12130040010 passend zu Steyr T80,84,86, 180a,182,185	47,90 14,90	
63212	Kabelbaum passend zu Steyr T188	159,90 132,50		84586	Typenschild passend zu Steyr T80/T280	10,90 9,10	
63491	Kabelbaum passend zu Steyr T180a - 30PS	178,90 149,10		74813	Kurbelhalter	21,90 18,30	

Zapfwellen

Nr.	Bezeichnung	€
56626	Zapfwellenwelle L = 835 mm, Z = 20 verwendbar anstelle von: 29527003 zu Steyr Plus 658-768	228,90 190,80



97360	Zapfwellenendstück L = 182,6 mm verwendbar anstelle von: 47132584, 5196960 passend zu Steyr: CVT: 6130, 6135, 6140, 6145, 6160, 6165, 6170, 6180, 6185, 6200, 6205, 6210, 6215, 6225, 6230, Profi: 4100, 4110, 4115, 4120, 4130, 6115, 6125, 6140	164,50 137,10
-------	--	------------------------------------



97361	Zapfwellenendstück L = 182,5 mm verwendbar anstelle von: 47130743, 5182612 passend zu Steyr: CVT: 6130, 6135, 6140, 6145, 6160, 6165, 6170, 6180, 6185, 6200, 6205, 6210, 6215, 6225, 6230, Profi: 4100, 4110, 4115, 4120, 4130, 6115, 6125, 6140	158,90 132,40
-------	--	------------------------------------



97362	Zapfwellenendstück L = 182,6 m, Z = 21 verwendbar anstelle von: 47130744, 5182613 passend zu Steyr: CVT: 6130, 6135, 6140, 6145, 6160, 6165, 6170, 6180, 6185, 6200, 6205, 6210, 6215, 6225, 6230, Profi: 4100, 4110, 4115, 4120, 4130, 6115, 6125, 6140	158,90 132,40
-------	---	------------------------------------



Karosserieteile

56620	Motorhaube verwendbar anstelle von: 293130130 passend zu Plus 4 Zylinder 50,60, 650,658,760,768	359,00 299,20
-------	---	------------------------------------



60925	Seitenblech unten re. gelocht verwendbar anstelle von: 293130113	86,90 72,40
-------	---	----------------------------------



60926	Seitenblech unten li. gelocht verwendbar anstelle von: 293130113	86,90 72,40
-------	---	----------------------------------

50703	Seitenteil li. passend zu Plus 3 Zylinder Plus 30,40, 540,545,548	241,90 201,60
-------	--	------------------------------------



50704	Seitenteil re. passend zu Plus 3 Zylinder Plus 30,40, 540,545,548	241,90 201,60
-------	--	------------------------------------

56597	Seitenteil li. verwendbar anstelle von: 396130006	249,00 207,50
-------	--	------------------------------------



56596	Seitenteil re. verwendbar anstelle von: 396130005 passend zu Plus 4 Zylinder Plus 50,60, 650,658,760,768	249,00 207,50
-------	--	------------------------------------

56621	Scharnier verwendbar anstelle von: 293130146	15,60 13,00
-------	---	----------------------------------



56622	Scharnier verwendbar anstelle von: 293130147	15,60 13,00
-------	---	----------------------------------

91896	Gummiteil verwendbar anstelle von: 293130066	3,20 2,70
-------	---	--------------------------------



61201	Anschlaggummi für Motorabdeckung verwendbar anstelle von: 199967001 passend zu Steyr	6,40 5,30
-------	--	--------------------------------



50706	Gummi für Seitenteilbefestigung	2,90 2,40
-------	------------------------------------	--------------------------------



91895	Gummipuffer verwendbar anstelle von: 293130067	1,90 1,60
-------	---	--------------------------------



64589	Anhängebock verwendbar anstelle von: 1295930007 passend zu Steyr Plus Serie	124,90 104,10
-------	--	------------------------------------



80660	Achsschenkelbüchse 30x35x30 mm passend zu Steyr T80	19,50 16,30
-------	---	----------------------------------



80662	Achsschenkelbüchse 32x38x45 mm passend zu Steyr T188ob	23,90 19,90
-------	--	----------------------------------



80663	Achsschenkelbüchse 35x40x55 mm passend zu Steyr T84e, T188 unten	23,90 19,90
-------	--	----------------------------------



87679	Achsschenkelbüchsen 35x30x35mm passend zu Steyr T180, T180a oben	25,90 21,60
-------	--	----------------------------------



87680	Achsschenkelbüchsen 40x35x27mm passend zu Steyr T180, T180a unten	25,90 21,60
-------	---	----------------------------------



87681	Achsschenkelbüchse 38x32x45mm passend zu Steyr T84e oben	35,90 29,90
-------	--	----------------------------------



87683	Herzbolzenbüchse 35x30x45mm passend zu Steyr T180, T80	36,90 30,80
-------	--	----------------------------------



87684	Federbolzen 7x20x118mm passend zu Steyr T180, T180a	25,90 21,60
-------	---	----------------------------------



87685	Federbolzen Übermaß 7x21x118mm passend zu Steyr T180, T180a	31,90 26,60
-------	---	----------------------------------



87686	Federblattbüchse 25x20x70mm passend zu Steyr T180, T180a	18,90 15,80
-------	--	----------------------------------



87687	Federblattbüchse Übermaß 25x21x70mm passend zu Steyr T180, T180a	14,90 12,40
-------	--	----------------------------------



87688	Lenkstockhebelbüchse 31x28x35mm passend zu Steyr T80, T180, T180a	16,90 14,10
-------	---	----------------------------------



87689	Zapfwellenbüchse 22x18x20mm passend zu Steyr T80	21,90 18,30
-------	--	----------------------------------



Karosserieteile

Nr.	Bezeichnung	€		Nr.	Bezeichnung	€	
87690	Zapfwellenbüchse 25x20x20mm passend zu Steyr T180	24,90 18,30		80544	Kotflügel re. Farbe grau grundiert Höhe 540 mm passend zu Plus 40,540,545,548	749,00 624,20	
87691	Lenkrandbüchse Alu mit Bund 40x22x31mm passend zu Steyr T80, T180, T180a	28,90 24,10		80545	Kotflügel li. Farbe grau grundiert Höhe 540 mm passend zu Plus 40,540,545,548	749,00 624,20	
87692	Lenkrandbüchse Alu mit Bund 40x25x30mm passend zu Steyr T185, T280	19,90 16,60		56599	Kotflügel re. Farbe grau grundiert Höhe 720mm passend zu Plus 50,650,658, 60,760,768	649,00 540,80	
87693	Sitzbefestigungsschraube mit M16 Gewinde passend zu Steyr T180, T80	25,90 21,60		56600	Kotflügel li. Farbe grau grundiert Höhe 720mm passend zu Plus 50,650,658, 60,760,768	649,00 540,80	
87695	Federblattbolzen 30 mm passend zu Steyr T185, T280	44,90 37,40		91879	Kotflügel re. Höhe = 650 mm passend zu Steyr Plus	758,90 632,40	
87694	Ölschleuderring für Kurbelwelle 82x70x35mm passend zu Steyr T80, T180	148,90 82,40		91880	Kotflügel li. Höhe 650 mm passend zu Steyr Plus	758,90 632,40	
87696	Federblattbüchse 30 mm passend zu Steyr T185, T280	46,70 38,90		60806	Gummilager für Kotflügel passend zu Steyr Plus	23,90 19,90	
87697	Achsschenkelbüchsen 52x45x44 mm passend zu Steyr T185, T280 oben	35,40 29,50		80668	Kotflügel vorne links	258,90 215,80	
87698	Achsschenkelbüchsen 62x55x48 mm passend zu Steyr T185, T280 unten	48,80 40,70		80669	Kotflügel vorne rechts passend zu Plus Serie	258,90 215,80	
87699	Herzbolzenbüchse 65x55x65 mm passend zu Steyr T185, T280	70,60 58,80		86928	Halterung für Plus 3 Zylinder (1Kotflügel)	34,90 29,10	
87700	Sechskantmutter für Hinterachse mit Linksgewinde passend zu 30er Steyr T180	134,90 112,40		86929	Halterung für Plus 4 Zylinder (1Kotflügel)	34,90 29,10	
87701	Sechskantmutter für Hinterachse mit Rechtsgewinde passend zu 30er Steyr T180	134,90 112,40		80717	Werkzeugbox Metall grundiert passend zu Steyr Serie Plus	66,90 55,80	
87702	Flachkantmutter für Hinterachse mit M40x1,5 Linksgewinde passend zu 26er Steyr T180	58,90 49,10		92026	Frontgrill passend zu Steyr Serie Plus	258,90 215,80	
87703	Flachkantmutter für Hinterachse mit M40x1,5 Rechtsgewinde passend zu 26er Steyr T180	58,90 49,10					
86121	Sicherungsblech passend zu Steyr T180	10,90 9,10					

Karosserieteile

Nr.	Bezeichnung	€
90206k	Frontgrillset	358,90 299,10
Set besteht aus:		
- Motorhaube 90206		
- Steyr Zeichen 56598		
- Scheinwerfer 51699		
- Lampe 00439		
passend zu Steyr Serie Plus		



93679	Feder L = 100 mm zu Motorhaubenverriegelung	4,50 3,80
verwendbar anstelle von: 68033508, 168033508		
passend zu Steyr Plus Serie		



93680	Feder zu Frontmaske L = 70 mm	4,30 3,60
verwendbar anstelle von: 28857057, 128857057		
passend zu Steyr Plus Serie		



93681	Haken zu Frontmaske	2,80 2,30
verwendbar anstelle von: 28835047, 128835047		
passend zu Steyr Plus Serie		



Kotflügel hinten

unlackiert, 2 mm stark (beim Original 1,8 mm)
passend zu Steyr 8065, 8075, 8085, 8095



Nr.	Bezeichnung	verwendbar anstelle von	€
95983	Kotflügel hinten re.	134425201	599,00 489,00
95984	Kotflügel hinten li.	134425202	599,00 489,00

passend zu Steyr 8045, 8055



Nr.	Bezeichnung	verwendbar anstelle von	€
95987	Kotflügel hinten re.	134425102	559,00 469,00
95988	Kotflügel hinten li.	134425101	559,00 469,00

passend zu Steyr 955, 964, 968, 970, 975, MWM



Nr.	Bezeichnung	verwendbar anstelle von	€
65263	Kotflügel re.	134525206	679,00 565,80
65264	Kotflügel li.	134525207	679,00 565,80
verwendbar anstelle von: passend zu Steyr 955, 964, 968, 970, 975, MWM			

Kotflügelverbreiterung vorne

passend zu Steyr 8045, 8055, 8065, 8075, 8085, 8095 - schmale Ausführung

Nr.	Bezeichnung	b mm	Loch Ø	verwendbar anstelle von	€
95981	Verbreiterung vorne re.	95	M6	134701493	112,90 94,10
95982	Verbreiterung vorne li.	95	M6	134701492	112,90 94,10



passend zu Steyr 8065, 8075, 8085, 8095 - breite Ausführung

Nr.	Bezeichnung	b mm	Loch Ø	€
95979	Verbreiterung vorne re.	220	M6	118,90 99,10
95980	Verbreiterung vorne li.	220	M6	118,90 99,10



Kotflügel

passend zu Steyr 8060, 8070, 8080, 8090

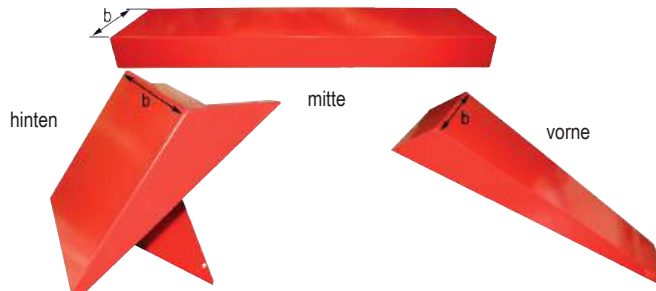

Nr.	Bezeichnung	Ausführung	b mm	verwendbar anstelle von	€
95957	Kotflügel vorne re.	lang	180	134325101	104,90 89,90
95958	Kotflügel vorne li.	lang	180	134325102	104,90 89,90
95959	Kotflügel Mittelteil		180	134125080	168,90 140,80
95960	Kotflügel hinten re.		430	134325103	146,90 128,90
95961	Kotflügel hinten li.		430	134325104	146,90 128,90

Kotflügel

passend zu Steyr 8070 teilweise, 8080, 8090

Nr.	Bezeichnung	Ausführung	b mm	verwendbar anstelle von	€
95962	Kotflügel vorne re.	lang	265	134325115	128,90 107,40
95963	Kotflügel vorne li.	lang	265	134325116	128,90 107,40
95964	Kotflügel Mittelteil		265	134125082	208,90 174,10
95965	Kotflügel hinten re.		520	134325113	156,90 134,90
95966	Kotflügel hinten li.		520	134325114	156,90 134,90

passend zu Steyr 8100, 8110, 8120, 8130

Nr.	Bezeichnung	Ausführung	b mm	verwendbar anstelle von	€
95967	Kotflügel vorne re.	lang	350	134325117	165,90 138,30
95968	Kotflügel vorne li.	lang	350	134325118	165,90 138,30
95969	Kotflügel Mittelteil		350	134125083	204,90 170,80
95970	Kotflügel hinten re.		610	134325109	149,90 124,90
95971	Kotflügel hinten li.		610	134325110	149,90 124,90

Aufkleber

Nr.	Bezeichnung	€	
72013	Aufkleber Diesel + Steyr	12,90 10,80	
72014	Aufkleber Diesel-Steyr	4,50 3,80	
72015	Aufkleber Steyr Ø 73 mm	4,50 3,80	
72016	Aufkleber KL II	4,60 3,80	
72012	Aufkleber KL I	4,50 3,80	
72017	Aufkleber Made in Austria	3,90 3,30	
72018	Aufkleber II	4,50 3,80	
72019	Aufkleber Achtung	4,50 3,80	
72021	Aufkleber Fuel Tank	4,90 4,10	
72022	Aufkleber Luftfilter durch Klopfen reinigen	4,90 4,10	
71996	Aufkleber Steyr Logo 165 x 40 mm	4,50 3,80	

Typenschilder und Aufkleber

Nr.	Bezeichnung	€	
56598	Steyr Zeichen verwendbar anstelle von: 1600110039	13,90 11,60	
77172	Aufkleber-Paar für Steyr Plus Serie 30	22,90 19,10	
77173	Aufkleber-Paar für Steyr Plus Serie 430	22,90 19,10	
77174	Aufkleber-Paar für Steyr Plus Serie 40	22,90 19,10	
77175	Aufkleber-Paar für Steyr Plus Serie 540	22,90 19,10	
77176	Aufkleber-Paar für Steyr Plus Serie 545	22,90 19,10	
63485	Zeichen passend zu Steyr T180, T180a, N180a	49,00 40,80	
77101	Zeichen für Steyr T83/188	33,90 28,30	
99882	Zeichen zu Steyr rot chrom 2 Schrauben Befestigung verwendbar anstelle von: 1897712, 1189770012, 1189770012N	38,90 32,40	
99881	Zeichen zu Steyr grün chrom Länge = 108 Breite = 24 mm 2 Schrauben Befestigung	34,90 29,10	
77102	Typenschild Länge = 110 Breite = 25 mm rechteckig, klein verwendbar anstelle von: 1817712 passend für 80/180	22,90 19,10	
77103	Typenschild Länge = 157 Breite = 37 mm rechteckig, groß verwendbar anstelle von: 2817701 passend für 180a/185/185a/280/280	29,90 24,90	

Typenschilder

Nr.	Bezeichnung	€
96579	Schriftzug Steyr T180	35,90 29,90
91893	Schriftzug Steyr T188	38,90 32,40
91894	Schriftzug Steyr T180a	35,90 29,90
94514	Schriftzug Steyr T190	35,90 29,90
96581	Schriftzug Steyr T288	35,90 29,90
96580	Schriftzug Steyr T290	35,90 29,90

Steyr 180

Steyr 188

Steyr 180a

Steyr 190

Steyr 288

Steyr 290

Haubenhalter Universal

Nr.	Bezeichnung	€
77122	Haubenhalter gerade L = 90 mm	24,90 20,80
77123	Haubenhalter 90 Grad L = 100 mm	24,90 18,30
77124	Haubenhalter L = 60 mm	24,90 18,30
77125	Haubenhalter L = 85 mm	23,90 19,90



Wellendichtringe

Nr.	Bezeichnung	€
55905	Dichtring vorne 50x65x8 passend zu Plus Serie WD306, WD406	8,90 7,40
55906	Dichtring hinten 85x105x11 passend zu Plus Serie WD306, WD406	46,90 14,10



Nr.	Bezeichnung	€
56614	Wellendichtring 100x120x14	24,90 18,30
55995	Wellendichtring 110x145x13	24,90 18,30
55989	Wellendichtring 90x110x13	9,90 8,30
55897	Wellendichtring vorne 95 x 115 x 12 mm Viton Ausführung	48,90 40,80
55898	Wellendichtring hinten 90x110x12 Viton Ausführung passend zu 8045, 8055, 8060, 8065, 8070, 8075, 8080, 8085, 8090, 8100, 8110, 8120, 8130, WD311, WD411	38,90 32,40
60782	Dichtung Wellendichtring hinten verwendbar anstelle von: 1406010087 passend zu WD: 307, 308, 407, 408	4,40 3,70
40048	Wellendichtring vorne 56x76x9,5	8,90 7,40
40049	Wellendichtring hinten 135x159x10,5 passend zu 948,952,958,963	49,90 16,90
55889	Wellendichtring vorne 78x100x13	38,90 32,40
55890	Wellendichtring hinten 110x130x13, Motortype MWM passend zu 955,964,970,968, 9078,9086,9094	34,90 29,10
55888	Wellendichtring vorne 58x80x12	43,90 11,60
55887	Wellendichtring hinten 110x140x12, Motortype Sisu, Valmet passend zu 667,680,975,6135,6145, 6170,6190,9078,9086,9094,9078,9080, 9086,9090,9094,9100,9105,9115,915, 9145,CVT120,130,150,170	32,90 27,40
64671	Wellendichtring 190 x 163 x 15 mm verwendbar anstelle von: 5184116, 5137109, 5177708, 10667 passend zu CVT: 6130, 6145, 6250 Terrus Kompakt: 4065, 4075, 4085, 4095 Multi: 4095, 4100, 4105, 4110, 4115, 4120 Profi: 4100, 4110, 4115, 4120, 4130, 6115, 6125, 6135, 6140	46,90 39,10



Motordichtungen

Nr.	Bezeichnung	€
54210	Kopfdichtung zu Steyr T188, T290	44,90 37,40
54215	Kopfdichtung zu Steyr WD307 Ø 98 mm bis Motor Nr.: 6920	94,90 79,10
54212	Kopfdichtung zu Steyr WD308/311 Marke Elring	98,90 82,40
56465	Kopfdichtung zu Steyr WD308/311	36,90 30,80



Motordichtungen

Nr.	Bezeichnung	€		Nr.	Bezeichnung	€	
92045	Kopfdichtung Bohrung 92 mm Marke Elring passend zu Steyr 406A	119,90 99,90		77444	Kopfdichtsatz verwendbar anstelle von: MWM	75,90 63,30	
80869	Kopfdichtung Bohrung 98 mm WD406/407 (Tropfen)	114,90 95,80		54220	Entrußersatz CU 0,8 mm passend zu T80,T84, T180,T182,T185	19,90 16,90	
54216	Kopfdichtung Bohrung 100 mm WD408 (Tropfen)	119,90 99,90		54545	Entrußersatz CU 1,0 mm passend zu T: 80, 84, 86, 180a, 182, 185, 280	24,90 20,80	
54213	Kopfdichtung WD408/411/407 Marke Elring	99,90 83,30		54546	Entrußersatz CU 1,2 mm passend zu T80-86	24,90 20,80	
56466	Kopfdichtung WD408/411	40,90 34,10		96041	Dichtring-Vorkammer verwendbar anstelle von: 2130428 passend zu Steyr T: 80,84,86, 180a,185,280	21,90 18,30	
80984	Kopfdichtung passend zu Steyr WD410	98,90 82,40		93674	Zylinderkopfdichtsatz 2-Zylinder passend zu Steyr Plus 30/430	114,90 95,80	
61288	Kopfdichtung passend zu Steyr WD610 1090, 1100	289,00 240,80		54226	Entrußersatz zu Steyr T188	48,90 40,80	
54214	Kopfdichtung zu Steyr WD611 Marke Elring	182,90 152,40		54231	Entrußersatz passend zu 190 WD306a-307c-307	58,90 49,10	
54230	Kopfdichtung zu Steyr WD612 Marke Elring	125,90 104,90		54211	Entrußersatz passend zu T288, T290 passend zu Steyr T288, T290, WD406,	59,90 49,90	
60774	Kopfdichtung verwendbar anstelle von: 16110000018 passend zu WD611	74,90 62,40		54221	Entrußersatz zu Steyr WD308 passend zu Plus 40-548	38,40 32,00	
95912	Zylinderkopfdichtsatz zu Motortype Sisu 320 verwendbar anstelle von: 132000010722, 1451728, V836640289, V83664028 passend zu Steyr 667, 680, 968, 975;	129,90 108,30		54222	Entrußersatz zu Steyr WD408 passend zu Plus 50-768	49,90 41,60	
95914	Zylinderkopfdichtsatz zu Motortype Sisu 420 verwendbar anst. von: 836740280, 142080040703, V836740280 passend zu 667, 670, 680, 9086, 9105, -M: 9080, 9090, 9100, M: 9078, 9086, 9094, -MT: 9080, 9090, 9100	269,00 224,20		54223	Entrußersatz zu Steyr WD311 passend zu 8045,8055,8065	52,90 44,10	
95916	Zylinderkopfdichtsatz zu Motortype Sisu 620 verwendbar anstelle von: 162084010705, V836840237 passend zu Steyr 9115, 9125, 9145;	219,90 183,30		54224	Entrußersatz zu Steyr WD411 passend zu 8070,8080,8090	88,90 74,10	
56401	Kopfdichtung verwendbar anstelle von: MWM passend zu 968,978,9078,9086,9094	21,10 17,60		54225	Entrußersatz zu Steyr WD611	91,90 76,60	
56463	Krümmerdichtung MWM passend zu 968,978, 9078,9086,9094	4,90 4,10		54229	Entrußersatz zu Steyr WD612	118,90 99,10	
56464	Ansaugkrümmerdichtung MWM passend zu 968,978, 9078,9086,9094	11,40 9,50					

Dichtungen

Nr.	Bezeichnung	€	Nr.	Bezeichnung	€	
54232	Entrußersatz passend zu 870 WD410T	93,90 78,30	56460	Ventildeckeldichtung MWM passend zu 968,978,9078,9086,9094	4,90 4,10	
84610	Dichtsatz kpl. passend zu WD610 flache ÖWD	272,90 227,40	54595	Ölwannendichtung zu Steyr T188	74,90 62,40	
56461	Ventildeckeldichtung zu 3 Zylinder	8,90 7,40	61116	Ölwannendichtung passend zu T190	14,90 12,40	
56462	Ventildeckeldichtung zu WD408	5,90 4,90	54233	Ölwannendichtung zu Steyr T288	16,90 14,10	
56468	Ventildeckeldichtung zu WD411	9,90 8,30	54536	Ölwannendichtung zu Steyr 311	42,90 35,80	
59561	Ventildeckeldichtung zu Steyr 188,870,980..	9,50 7,90	54537	Ölwannendichtung zu Steyr 411	56,90 47,40	
95920	Ventildeckeldichtung zu Motortype: Sisu 320, 620 verwendbar anstelle von: 162000040700, V836646360 passend zu Steyr 667, 680, 968, 975;	18,90 15,80	54538	Ölwannendichtung zu Steyr 611	59,90 49,90	
95921	Ventildeckeldichtung zu Motortype Sisu 420D verwendbar anst. von: 142000040701, 142000040705, V836746362 passend zu Steyr 667, 680, 9105, M: 9078, 9086, 9040, -M: 9080, 9090, 9100, -MT: 9080, 9090, 9100	9,90 8,30	95917	Ölwannendichtung zu Motortype Sisu 320 verwendbar anstelle von: 354103A1, V836006704 passend zu Steyr 667, 680, 968, 975	16,90 14,10	
95922	Gummiring zu Ventildeckel zu Motortype Sisu 320, 420, 620 verwendbar anst. von: 162000040702 passend zu Steyr 667, 680, 968, 975, 9105, 9115, 9125, 9145, M: 9078, 9086, 9040, -M: 9080, 9090, 9100, -MT: 9080, 9090, 9100, M 9078	6,90 5,80	95918	Ölwannendichtung zu Motortype Sisu 420 verwendbar anstelle von: V89617600, 162000150713, V836129728 passend zu Steyr 667, 680, 9086, 9105, M: 9078, 9086, 9094, -M: 9080, 9090, 9100, MT: 9080, 9090, 9100	28,90 24,10	
95923	O-Ring zu Ventildeckel zu Motortype Sisu 320, 420, 620 verwendbar anst. von: 162000040760 passend zu Steyr 667, 680, 968, 975, 9086, 9105, 9115, 9125, CVT 6140, 6150, 6160, 6175, 6195, M: 9078, M: 9080, 9090, 9100, -MT: 9080, 9090, 9100	1,50 1,30	95919	Ölwannendichtung zu Motortype Sisu 620 verwendbar anstelle von: V836322183, 162000150700, V837074624 passend zu Steyr 9115, 9125, 9145	39,90 33,30	
95151	Ventildeckeldichtung zu Motortype FPT F4 verwendbar anstelle von: 2852033, J930906, J902666, J929795 passend zu CNH-Steyr Kompakt: 485, 495, 4085, 4095, 4100, -Profi: 6115	6,40 5,10	54541	Dichtsatz 10-teilig zu Steyr T80, 84, 86 Motordichtsatz unten	18,90 15,80	
54547	Deckeldichtung oben zu Steyr T80	15,90 13,30	54542	Dichtsatz 10-teilig zu Steyr T180, 182 Motordichtsatz unten	23,90 19,90	
			54543	Dichtsatz 10-teilig zu Steyr T185 Motordichtsatz unten	42,90 35,80	
			54544	Dichtsatz 10-teilig zu Steyr T280 Motordichtsatz unten	51,90 43,30	

Dichtungen

Nr.	Bezeichnung	€
54540	Stirndeckeldichtung zu Steyr 311-611	49,90 41,60

54556	Dichtung zu Armaturen Brett	8,50 7,10
-------	-----------------------------	---------------------

54593	Dichtung Getriebegehäuse zu Steyr	11,90 9,90
-------	-----------------------------------	----------------------

54594	Dichtung Deckel seitlich zu Steyr T180	4,20 3,50
-------	--	---------------------

54592	Deckel oben zu Steyr T180	24,90 18,30
-------	---------------------------	-----------------------



Ventile

Nr.	Bezeichnung	€
54270	Einlassventil Ø = 52 mm	25,90 21,60

54271	Auslassventil Ø = 48 mm passend zu Steyr T: 80, 84, 86, 180a, 182, 185, 280	23,90 19,90
-------	---	-----------------------

78203	Ventilführung 67 mm verwendbar anstelle von: 213040072 passend zu Steyr T: 80, 84, 86, 180a, 182, 185, 280	15,90 13,30
-------	---	-----------------------

80666	Ventilführung 66 mm verwendbar anstelle von: 406040603 passend zu Steyr	5,90 4,90
-------	---	---------------------

80667	Ventilführung 74 mm verwendbar anstelle von: 31100040029 passend zu Steyr	5,90 4,90
-------	---	---------------------

96037	Einlassventil verwendbar anstelle von: 406050006 passend zu Steyr T: 190, 288, 290	31,90 26,60
-------	--	-----------------------

96038	Auslassventil verwendbar anstelle von: 406050007 passend zu Steyr T: 190, 288, 290	27,90 23,30
-------	--	-----------------------

54322	Einlassventil Ø = 42 mm verwendbar anstelle von: 31100050014	18,90 15,80
-------	---	-----------------------

54323	Auslassventil Ø = 37 mm verwendbar anstelle von: 31100050015 passend zu Steyr WD408/WD411	17,90 14,90
-------	---	-----------------------

80868	Keilpaar passend zu Ventile Steyr 54322 / 54323	4,90 4,10
-------	---	---------------------

87601	Einlassventil breit Nut Ø = 42 mm passend zu Steyr Plus	30,30 25,30
-------	--	-----------------------

87602	Auslassventil breit Nut Ø = 37 mm passend zu Steyr Plus	28,20 23,50
-------	--	-----------------------



80985	Einlassventil Ø = 45 mm passend zu Steyr 188, 430, 870, 1090, 1100	31,90 26,60
-------	--	-----------------------

80986	Auslassventil Ø = 39 mm passend zu Steyr 188, 430, 870, 1090, 1100	31,90 26,60
-------	--	-----------------------

94845	Keilpaar zu 80985/80986	4,10 3,40
-------	----------------------------	---------------------

54281	Stößelbüchse passend zu Plus Serie	17,90 14,90
-------	---------------------------------------	-----------------------

91930	Ventileinstellschraube verwendbar anstelle von: 405050024 passend zu Plus Serie	12,50 10,40
-------	---	-----------------------

96039	Ventilfeder verwendbar anstelle von: 41390539 passend zu T: 80, 84, 86, 180a, 182, 185, 280	28,90 24,10
-------	--	-----------------------

91931	Ventilfeder verwendbar anst. von: 406050036 passend zu Plus Serie	12,50 10,40
-------	---	-----------------------



Kurbelwellen

Nr.	Bezeichnung	€
56628	Kurbelwelle 4 Zyl. zu Steyr WD406, WD408 passend zu T288/T290/50/650 /658/60/760/768 verwendbar anstelle von: 40602012	739,90 616,60

56629	Kurbelwelle 3 Zyl. zu Steyr WD308 passend zu T190/40,540,545,548,8045 verwendbar anstelle von: 308020028	799,90 665,80
-------	---	-------------------------

56569	Kurbelwelle 4 Zyl. zu Steyr WD411 Serie 80 (ohne Zahnrad vorne)	969,90 807,50
-------	---	-------------------------

97973	Motorblock passend zu Steyr WD-408, 4-Zylinder Plus 40-768	1799,90 1499,20
-------	---	---------------------------

60927	Ölwanne passend zu Steyr WD-407, WD-408	218,90 182,40
-------	---	-------------------------



Pleuellager

77363	Pleuellager MWM TD226-B3, TD226-B4, TD226-6	39,90 33,300
-------	--	------------------------

54290	Pleuellager Standard passend zu T: 80, 84, 86, 180a, 185, 280	67,90 56,60
-------	--	-----------------------

96020	Pleuellager Übermaß 0,25 mm passend zu T: 80, 84, 86, 180a, 185, 280	128,90 107,40
-------	---	-------------------------

96021	Pleuellager Übermaß 0,50 mm passend zu T: 80, 84, 86, 180a, 185, 280	128,90 107,40
-------	---	-------------------------



Pleuellager

Nr.	Bezeichnung	€
96022	Pleuellager Standard passend zu T188	94,90 76,60
96023	Pleuellager Übermaß 0,25 mm passend zu T188	118,80 99,00
96024	Pleuellagersatz Übermaß 0,25 mm 4 Paar passend zu T: 190, 288, 290, WD306a	65,90 54,90
96025	Pleuellagersatz Übermaß 0,50 mm 4 Paar passend zu T: 190, 288, 290, WD306a	68,90 57,40
96026	Pleuellagersatz Übermaß 0,75 mm 4 Paar passend zu T: 190, 288, 290, WD306a	65,90 54,90
54293	Pleuellager 1 Paar Marke Mibra passend zu WD311/411/611	45,90 38,30
54498	Pleuellager 1 Paar passend zu WD311/411/611	49,90 16,60
63734	Pleuellager Übermaß 0,25 mm 1 Paar passend zu WD311, WD411, WD611	34,90 26,60
63735	Pleuellager Übermaß 0,50 mm 1 Paar passend zu WD311, WD411, WD611	32,90 27,40
56602	Pleuellagersatz 4 Paar passend zu WD 307,308,406,407,408	48,90 40,80
96033	Hauptlagersatz Standard 5 Paar passend zu Steyr T: 190, 288, 290	79,90 66,60
96034	Hauptlagersatz Übermaß 0,25 mm 5 Paar passend zu Steyr T: 190, 288, 290	85,90 71,60
96035	Hauptlagersatz Übermaß 0,50 mm passend zu Steyr T: 190, 288, 290	85,90 71,60
96036	Hauptlagersatz Übermaß 0,75 mm passend zu Steyr T: 190, 288, 290	85,90 71,60
56601	Hauptlagersatz 5 Paar passend zu WD308,408	108,90 90,80
95907	Pleuellager zu Motortype Sisu 320, 420, 620 verwendbar anstelle von: 162000030702, V836110552 passend zu Steyr 667, 680, 9105, 9115, 9125, 9145, CVT: 120, 130, 150, 170, 6135, 6145, 6155, 6170, 6190, 6195, M: 968, 975, 9078, 9080, 9086, 9090, 9094, 9100	27,90 23,30
54272	Hauptlager 1 Paar, Marke Mibra passend zu WD311/411	58,00 48,30
80718	Hauptlager 1 Paar zu Steyr WD311/WD411	45,90 13,30
95908	Hauptlager zu Motortype Sisu 320, 420, 620 verwendbar anstelle von: 162000010781, 162000010713 passend zu 667, 680, 9105, 9115, 9125, 9145, 120, 130, 150, 170, 6135, 6145, 6155, 6170, 6190, 6195, M: 968, 975, 9078, 9086, 9094, -M: 9080, 9090, 9100	35,90 29,90

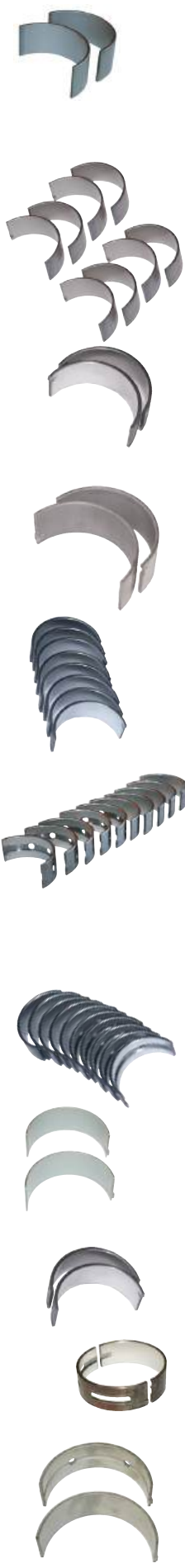

Nr.	Bezeichnung	€
54273	Anlaufscheiben 1 Paar passend zu WD311/411	69,90 58,30
54275	Anlaufscheibensatz 2 Paar passend zu Steyr WD 308/408	79,20 66,00
95909	Anlaufscheiben zu Motortype Sisu 320, 420, 620 passend zu 667, 680, 9105, 9115, 9125, 9145, CVT: 120, 130, 150, 170, 6135, 6145, 6155, 6170, 6190, 6195, M: 968, 975, 9078, 9086, 9094, M: 9080, 9090, 9100	49,50 16,30
60778	Pleuel passend zu WD-308, WD-408	128,90 107,40
96032	Pleuelschraube verwendbar anstelle von: 2130324 passend zu Steyr T: 80, 84, 86, 180a, 185, 280	21,90 18,30
54274	Pleuelschraube M10x1x62 passend zu WD 311, 411, 611, 406, 407, 308, 408	40,90 9,10
95910	Pleuelschraube TX-Stern L = 58 mm zu Motortype Sisu 320, 420, 620 verwendbar anstelle von: 142000030701 passend zu Steyr 667, 680, 9105, 9115, 9125, 9145, M: 968, 975, 9078, 9086, 9094, M: 9080, 9090, 9100, CVT 120, 130, 150, 170, 6135, 6145, 6155, 6170, 6190, 6195	16,90 14,10
95911	Pleuelschraube L = 85 mm zu Motortype Sisu: 320, 420, 620 verwendbar anstelle von: 162000030703 passend zu Steyr 667, 680, 9105, 9115, 9125, 9145, M: 968, 975, 9078, 9086, 9094, M: 9080, 9090, 9100, CVT 120, 130, 150, 170, 6135, 6145, 6155, 6170, 6190, 6195	32,90 26,70
96030	Pleuelbuchse-Rohling L = 46, AØ = 45, IØ = 39 mm passend zu T: 80/84/86, 180a, 185, 280	98,00 81,70
96031	Pleuelbuchse 40 x 34 x 34 mm verwendbar anstelle von: 407030011 passend zu Steyr T: 190, 288, 290	40,90 9,10
80710	Pleuelbüchse verwendbar anstelle von: 40703011 passend zu Steyr Plus	41,90 9,90



Zylinderkopf

Nr.	Bezeichnung	€
96016	Wasserrohr-Zylinderkopf verwendbar anstelle von: 413901169, 14139010169 passend zu Steyr T 80, 84, 86, 180, 180a, 182, 185, 280	45,90 13,30
96017	Wasserrohr verwendbar anstelle von: 12130010038 passend zu Steyr T180	21,90 18,30
87704	Wasserpfeife Messing für Zylinderkopf Außen 16mm verwendbar anstelle von: 14136010153, 1413C010004 passend zu T: 80, 84, 86, 180, 180a, 182, 185, 280	25,90 21,60



Zylinderkopf

Nr.	Bezeichnung	€
92708	Zylinderkopf passend zu Steyr T: 80, 84, 86, 180a	749,00 679,00



54282	Zylinderkopf kpl. mit Ventile passend zu 3 Zylinder WD308/311	799,00 665,80
-------	--	------------------------------------



54283	Zylinderkopf 1 Stk kpl. mit Ventile passend zu 4 Zylinder WD408/411	689,00 599,00
-------	--	------------------------------------



96012	Zylinderkopf-Stehbolzen L = 150 mm verwendbar anstelle von: 2130132 passend zu Steyr T: 80, 84, 86, 180, 180a, 185, 185a	33,90 28,30
-------	--	----------------------------------



96013	Zylinderkopf-Stehbolzen L = 175 mm verwendbar anstelle von: 2130131 passend zu Steyr T: 80, 84, 86, 180, 180a, 185, 185a	33,90 28,30
-------	--	----------------------------------



96014	Zylinderkopf-Mutter verwendbar anstelle von: 2130154 passend zu Steyr T: 80, 84, 86, 180, 180a, 185, 185a	7,90 6,60
-------	--	--------------------------------



96015	Zylinderkopf-Beilagscheibe verwendbar anstelle von: 2130168 passend zu Steyr T: 80, 84, 86, 180, 180a, 185, 185a	5,90 4,90
-------	---	--------------------------------



54278	Dehnschraube für Zylinderkopf passend zu M14 x 150	6,90 5,80
54298	Zylinderkopfschraube M12 x 130	12,50 10,40



90896	Nockenwellen Lagersatz m. 4 Stk. verwendbar anstelle von: 1609F010054	36,60 30,50
-------	---	----------------------------------



60916	Nockenwelle verwendbar anstelle von: 131100050024 passend zu WD-308	274,90 229,10
-------	--	------------------------------------



60917	Nockenwelle verwendbar anstelle von: 406050033 passend zu WD-408	328,90 274,10
-------	---	------------------------------------



Kolben, Ringe, Büchsen

Nr.	Bezeichnung	€
54240	Kolbenringsatz zu T80 5 Ringe	62,90 52,40



54250	Kolben, Ringe, Büchse, Bolzen zu Steyr T80/T84/T180/T182/T185	194,90 162,40
-------	--	------------------------------------



Nr.	Bezeichnung	€
54254	O-Ring rot	7,20 6,00
54255	O-Ring schwarz	3,50 2,90

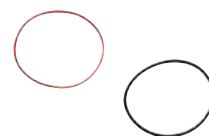

54251	Kolben, Ringe, Büchse, Bolzen 4-Ringe, Ø 100 mm Bolzen 35x83 zu Steyr WD308/408	148,90 124,10
-------	---	------------------------------------



60777	Kolben, Ringe, Bolzen zu Steyr WD308/408	115,90 96,60
-------	---	-----------------------------------



54241	Kolbenringsatz 4-Ringe, Ø 100 mm zu Steyr WD308/408	36,60 30,50
-------	---	----------------------------------



54252	Kolben, Ringe, Büchse, Bolzen 3-Ringe, Ø 100 mm Bolzen 38x79 zu Steyr WD311/411/611	168,90 140,80
-------	--	------------------------------------



80853	Kolbenringsatz 3-Ringe, Ø 100 mm passend zu Steyr WD311/411/611	32,90 27,40
-------	---	----------------------------------



56467	O-Ring für Büchsen zu Steyr WD308/408/311/411/611	4,90 4,10
-------	--	--------------------------------



53685	Kolben, Ringe, Büchse, Bolzen zu Steyr MWM WD301, WD401 verwendbar anstelle von: 90093960	158,90 132,40
-------	--	------------------------------------



64026	Büchsendichtring MWM dünn zu 53685	3,90 3,30
-------	---------------------------------------	--------------------------------



64027	Büchsendichtring MWM dick zu 53685	3,90 3,30
-------	---------------------------------------	--------------------------------



55987	Kolben, Ringe, Büchse, Bolzen Ø 98 mm zu Steyr T190/290	229,90 190,80
-------	---	------------------------------------



55988	Kolben, Ringe, Büchse, Bolzen Ø 92 mm zu Steyr T288 WD406	164,90 137,40
-------	---	------------------------------------



55985	Ringsatz Ø 92 mm passend zu Steyr T288	66,90 55,80
-------	--	----------------------------------



78946	O-Ring zu Steyr T288 (406)	5,90 4,90
-------	----------------------------	--------------------------------



Kolben, Ringe, Büchsen

Nr.	Bezeichnung	€
95906	Kolben, Ringe, Büchse, Bolzen Marke Kolbenschmidt 3 Ringe Ø 108 mm, Bolzen 40 x 89 mm zu Motor Sisu 320, 420, 620 verwendbar anst. von: 162000040705, 162000040706, 162000040783, 354138A1	325,90 271,60
95913	Kolben, Ringe, Büchse, Bolzen 3 Ringe Ø 108 mm, Bolzen 40 x 89 mm zu Motor Sisu 320, 420, 620 verwendbar anstelle von: 162000040763, 162000030700 passend zu Steyr 968, 975, 9105, 9115, 9125, 9145, M: 9078, 9086, 9094, -M: 9080, 9090, 9100, CVT: 120, 130, 150, 170, 6135, 6145	178,90 149,10
95915	O-Ringsatz 3 Ringe 115 x 3,5 mm 2x 836647502, 1x 836647503 zu Motor Sisu 320, 420, 620 verwendbar anst. von: 162000040706 passend zu Steyr 968, 975, 9105, 9115, 9125, 9145, M: 9078, 9086, 9094, -M: 9080, 9090, 9100, CVT: 120, 130, 150, 170, 6135, 6145	14,90 12,40

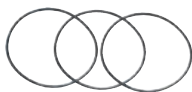

Motorreparaturset

Nr.	Bezeichnung	€
MR1	Motorrep- Kit zu Steyr WD308 3Zylinder passend zu Plus 40-548	499,00 415,80
MR2	Motorrep- Kit zu Steyr WD408 4Zylinder passend zu Plus 50-768	729,00 607,50
MR3	Motorrep- Kit zu Steyr WD311 3Zylinder passend zu 8045,8055,8065	739,00 615,80
MR4	Motorrep- Kit zu Steyr WD411 4Zylinder passend zu 8070,8080,8090	899,00 749,20
MR5	Motorrep- Kit zu Steyr WD611 6Zylinder passend zu Serie 80	1449,00 957,50
MR12	Motorrep- Kit zu Steyr MWM, WD301 3 Zylinder passend zu Serie 9000	699,00 582,50
MR13	Motorrep- Kit zu Steyr MWM, WD401 4 Zylinder passend zu Serie 9000	849,00 707,50
MR15	Motorrep.-Kit zu Steyr WD306A passend zu T190	769,00 640,80
MR17	Motorrep.-Kit zu Steyr T288	899,00 749,20
MR20	Motorrep.-Kit zu Steyr T290	949,00 790,80



Ölmesstab

Nr.	Bezeichnung	€
54324	Messstab verwendbar anstelle von: 406 01 0606 passend zu Steyr Plus 40, 540, 545,548,50,650,658,60,768,8045	9,90 8,30



Nr.	Bezeichnung	€
53708	Ölablassschraube verwendbar anst. von: 33700210024 mit Magnet, Gewinde M30x1,5	13,50 11,30
95927	Ölablassschraube M38x1,5, SW22 passend zu Steyr T: 80, 84, 86, 180	16,90 14,10
54279	Öldeckel passend zu Steyr Plus	13,90 11,60
54280	Dichtung zu Öldeckel passend zu Steyr Plus	3,40 2,80
53730	Öldruckschalter M10x1 passend zu Steyr T190, T288, T290, Plus40, 540,545,548,8045,50, 650,658,60,760,768	6,90 5,80
53538	Öldruckanzeige mechanisch Ø 52 mm Anschluss M12x1,5	34,90 29,10
53732	Öldruckanzeige mechanisch Ø 60 mm Anschluss M12x1,5	32,90 27,40
54549	Gummiring für Armaturen 58/72	7,40 6,20
74818	Armaturenring innen 60 mm, außen 75 mm	8,90 7,40
95925	Anschlussleitung gerade zu Öldruckmanometer verwendbar anstelle von: 38095881, 138095881 passend zu T: 80, 84, 86	31,90 26,60
95926	Anschlussleitung gekröpft zu Öldruckmanometer verwendbar anstelle von: 380958114, 1380958114 passend zu T 188	27,90 23,30
63108	Sensor Motortemperatur & Öldruck verwendbar anst. 4890193, 504358206 passend zu Steyr: CVT: 6165, 6180, 6185, 6200, 6210, 6220, 6225, 6240, 6250 Terrus Profi: 4110, 4115, 4120, 4130, 6115, 6125, 6135, 6140	35,90 29,90
64552	Öldruckschalter Getriebe verwendbar anstelle von: 1397710007, 155700713003, 5840302122 passend zu Steyr: 8080, 8090 M: 9078, 9080, 9083, 9086, 9090, 9094, 9100	364,90 304,10

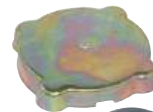

Ölpumpen

Nr.	Bezeichnung	€
64897	Ölpumpe verwendbar anstelle von: 21307602, 12130070602 passend zu 13er Baureihe, T80, T84	279,00 232,50
64915	Öldruckregelventil verwendbar anstelle von: 21307603, 12310070603E passend zu 13er Baureihe, N180a, N182a, T80, T84, T86, T180, T180a, T182	169,00 140,80



Nr. **Bezeichnung**
 54320 Ölpumpe kpl.
 verwendbar anst. von: 406 A 07 0601
 passend zu T190, T288, T290,
 Plus 40, 540, 545, 548, 8045, 50,
 650, 658, 60, 760, 768



456,90
130,80

92433 Ölpumpe
 verwendbar anst. von:
 161100070018, 131100070014,
 131100070013, 161100070017
 passend zu WD311, WD411, WD611



314,90
262,40

Froststopfen

Nr.	Bezeichnung	€	
78503	Froststopfen Ø 16,0 mm	1,40	1,20
40760	Froststopfen Ø 17,7 mm	1,40	1,20
92409	Froststopfen Ø 19,5 mm	1,40	1,20
92322	Froststopfen Ø 20,0 mm	2,00	1,70
40761	Froststopfen Ø 22,5 mm	1,40	1,20
40762	Froststopfen Ø 25,0 mm	1,50	1,30
92410	Froststopfen Ø 26,5 mm	1,60	1,30
78504	Froststopfen Ø 28,0 mm	1,80	1,50
91858	Froststopfen Ø 30,0 mm	2,90	2,40
40763	Froststopfen Ø 32,1 mm	1,70	1,40
40764	Froststopfen Ø 35,2 mm	1,80	1,50
40765	Froststopfen Ø 38,2 mm	1,90	1,60
78505	Froststopfen Ø 40,0 mm	2,30	1,90
78506	Froststopfen Ø 46,0 mm	2,50	2,10
40766	Froststopfen Ø 50,2 mm	2,60	2,20
78507	Froststopfen Ø 60,0 mm	3,90	3,30



Kupplung

Nr. **Bezeichnung**
 55941 Einfachkupplung Ø 225 mm
 passend zu 188, 190, 430
 Deutz, Fendt, Güldner, Kramer,
 Landini, IH, Lanz, O&K,
 Schlüter ältere Modelle



499,00
165,80

55942 Kupplungsscheibe
 Ø 225 mm 10Z/23x29
 passend zu 188, 430
 Claas, Eicher, Güldner, Kramer,
 Lanz, Lindner, Schlüter,
 ältere Modelle



99,00
82,50

55913 Kupplungsscheibe
 verwendbar anst. von:
 306A160707
 passend zu 190



409,00
90,80

Nr. **Bezeichnung**
 55914 Einfachkupplung
 verwendbar anstelle von:
 406160901



€
 218,90
182,40

55915 Kupplungsscheibe starr
 Ø 280 mm 10 Z / 28x35
 verwendbar anstelle von:
 2130160901
 passend zu 180, 190,
 288, 290, 40, 50



448,90
124,10

Nr. **Bezeichnung**
 55917 Einfachkupplung
 verwendbar anstelle von:
 407160902



€
 529,00
440,80

60918 Kupplungsscheibe gefedert
 Ø 280 mm, 10 Z / 28 x 35 mm
 passend zu Steyr



468,90
140,80

55915 Kupplungsscheibe starr
 Ø 280 mm, 10 Z / 28 x 35 mm
 verwendbar anstelle von: 407160906
 passend zu 540, 545, 548, 650, 658



448,90
124,10

95002 Einfachkupplung
 runde Tellerfederzungen
 46x50, 8 Nuten
 verwendbar anst. von: 408.00.16.0007,
 408.00.16.0754, 408.00.16.0903,
 408.00.16.0906
 passend zu Plus 60, 658, 760, 768



669,00
557,50

54337 Kupplungsscheibe
 Ø 310 mm 10Z/28x35
 verwendbar anstelle von: 40800160712
 passend zu 60, 295, 658, 760, 768



403,80
86,50

55938 Einfachkupplung
 verwendbar anstelle von:
 614160902



599,00
499,20

55923 Kupplungsscheibe starr
 Ø 350 mm 22Z/41x45
 verwendbar anst. von: 610T160703
 passend zu 870, 980, 1090, 1100, 1200
 8100, 8110, 8120, 8130



416,90
347,40

55924 Doppelkupplung
 verwendbar anstelle von:
 31100160708



4099,00
915,80

55925 Fahrkupplungsscheibe
 Ø 280 mm 17Z/28x32
 verwendbar anstelle von: 30100160003



205,50
171,30

55926 Zapfwellenkupplungsscheibe
 Ø 280 mm 24Z/45x50 Schmalspur
 verwendbar anstelle von: 41100160872
 passend zu 8055 bis Nr. 10791
 und 11004 bis 11106, 8060, 8070



224,90
187,40

55927 Doppelkupplung
 verwendbar anstelle von:
 41100160091



874,90
729,10

55925 Fahrkupplungsscheibe
 Ø 280 mm 17Z/28x32
 verwendbar anstelle von:
 30100160003

















205,50
171,30

55926 Zapfwellenkupplungsscheibe
 Ø 280 mm 24Z/45x50
 verwendbar anstelle von: 41100160093
 passend zu 8055 Nr. 10792-11003
 und ab 11107, 8065



224,90
187,40

Kupplung

Nr.	Bezeichnung	€		Nr.	Bezeichnung	€	
55930	Doppelkupplung	799,00		96083	Kupplungsscheibe gefedert Ø = 350 mm, Z = 21 verwendbar anstelle von: 335010726 161100160904, 161100160902 passend zu WD611, 8100, 8110, 8120, 8130	449,00 349,20	
	verwendbar anstelle von: 41100160871	665,80		55940	Kupplungsscheibe gefedert Ø = 350 mm, Z = 22	454,90 379,10	
	passend zu 8060 bis Nr. 21533, 8070 bis Nr. 21524			55950	Doppelkupplung DUT295	999,00 832,50	
55925	Fahrkupplungsscheibe	205,50		55951	Kupplungsscheibe gefedert Ø 290 mm 17Z/28x32 passend zu 942,948 mit Motor WD311, 964,970,968M bis Nr. 04939,955,975 3 Zylinder MWM	281,90 234,90	
	Ø 280 mm 17Z/28x32	171,30		55954	Doppelkupplung Steg 83 mm passend zu 942,948,958, 952M,963M,955, 964,975,968M	639,00 532,50	
	verwendbar anstelle von: 130100160003			55953	Kupplungsscheibe gefedert Ø 290 mm 15Z/25x28 passend zu 942,948,958	268,90 224,10	
	passend zu 8060, 8070 bis 21524			55956	Kupplungsscheibe Sinter Ø 290 mm 15Z/25x28 passend zu 952M,963M	299,00 249,20	
55931	Fahrkupplungsscheibe	403,80		55927	Doppelkupplung	874,90 729,10	
	Ø 295 mm 17Z/28x32	86,50			verwendbar anstelle von: 41100160091		
	verwendbar anstelle von: 41100160094			55931	Fahrkupplungsscheibe	403,80 86,50	
	passend zu 8070 ab 21525				Ø 295 mm 17Z/28x32		
55926	Zapfwellenkupplungsscheibe	224,90			verwendbar anstelle von: 41100160094		
	Ø 280 mm 24Z/45x50	187,40		55929	Zapfwellenkupplungsscheibe	489,00 157,50	
	verwendbar anstelle von: 411001600872				Ø 280 mm 24Z/45x50		
	passend zu 8060 bis Nr. 21533, 8070 bis Nr. 21524			55935	Doppelkupplung	929,00 774,20	
					verwendbar anstelle von:		
					40100160002		
55936	Fahrkupplungsscheibe	365,60		55957	Kupplungsscheibe Sinter Ø 290 mm 17Z/28x32 passend zu 955,964,975,968M, ab.Nr. DBD0040001	299,00 249,20	
	Ø 310 mm 17Z/28x32	304,70		93408	Kupplungsscheibe passend zu Steyr Serie 9000; Case: Serie CS	334,90 279,10	
	verwendbar anstelle von:			55958	Doppelkupplung DUT310/330 Steg 83 mm	449,00 374,20	
	41100160102			55960	Kupplungsscheibe Sinter 17Z/28x32 passend zu 9078,9083, 9086,9094, Valmet	299,00 249,20	
63349	Kupplungsscheibe starr	209,00		55955	Doppelkupplung DUT310 Steg 39 mm	849,00 707,50	
	Ø 310 mm 28 x 32 17 Zähne	174,20		55964	Kupplungsscheibe gefedert, Sinter passend zu 9078,9083,9086,9094, MWM M, 17 Z, 28x32	289,00 240,80	
	verwendbar anstelle von:						
	41100160105, 331009016						
	passend zu Steyr 8080, 8085, 8090, 8095						
55937	Zapfwellenkupplungsscheibe	284,90					
	Ø 310 mm 24Z/45x50	237,40					
	verwendbar anst. von: 41100160103						
	passend zu 8080,8090						
55938	Einfachkupplung	599,00					
	Ø 350 mm 24Z/41x45	499,20					
	verwendbar anstelle von: 614160018						
	passend zu 870,980,988,1090,1100, 1108,1200,1208,8100,8110,8120,8130						
55939	Kupplungsscheibe starr	359,00					
	verwendbar anstelle von:	299,20					
	61100160014						

Nr. Bezeichnung €
 55962 Doppelkupplung ~~1289,00~~
 DUT310/310 Steg 82,4 **1074,20**



55963 Kupplungsscheibe Sinter ~~449,00~~
 Ø 310 mm 23Z/46,5x51 **307,50**
 passend zu 9155,9170,9180



29416 Doppelkupplung ~~699,60~~
 6 Beläge, Ø = 327 mm, Z = 14 **583,00**
 verwendbar anstelle von:
 47134895, 87732503, 87732506
 passend zu Steyr Kompakt: 360,370,
 375,485,495,4065,4075,4085



64060 LUK-Doppelkupplung ~~958,90~~
 verwendbar anstelle von: **799,10**
 41100160024, 41100160030,
 41100160040, 41100160091,
 41100160923
 passend zu Steyr 8055,
 8065, 8075, 8085



63444 LUK-Kupplungssatz mit Lager ~~799,00~~
 Ø = 280 mm **665,80**
 verwendbar anst. von: 628318112,
 47134873, 47134884, 87732490,
 5796770, 47124886, 47134886
 passend zu Steyr
 Kompakt: 485, 495, 4065, 4075



63445 LUK-Einfachkupplung ~~649,00~~
 Ø = 280 mm, 3 Hebel **540,80**
 verwendbar anstelle von: 47134884,
 5196770, 5186548, 5186550, 87732490,
 47134873, 47134873, 128030210,
 47124886, 47134886
 passend zu Steyr
 Kompakt: 360, 370, 375, 485,
 495, 4065, 4075, 4085, 4095



63446 LUK-Kupplungssatz mit Lager ~~1089,00~~
 Ø = 280 mm **907,50**
 Zähne: 10, 4 Beläge
 verwendbar anstelle von:
 87689675, 628308610
 passend zu Steyr 370, 375,
 485, 495, 4065, 4075, 4085



63449 LUK-Kupplungssatz ~~4449,00~~
 Ø = 310 mm **932,50**
 verwendbar anstelle von:
 49700160901, 3580946M2,
 3713264M91, 3713266M1,
 3580944M92, 631087809
 passend zu 9155, 9170, 9190



63448 LUK-Kupplungssatz mit Lager ~~4469,00~~
 Ø = 280 mm **974,20**
 verwendbar anstelle von:
 5186555, 5196818, 228013610
 passend zu Steyr
 Kompakt: 360, 370, 375
 Synchro Shift



Nr. Bezeichnung €
 63447 LUK-Doppelkupplung ~~676,90~~
 Ø = 280 mm **564,10**
 verwendbar anstelle von:
 47134880, 47134898, 5196818
 passend zu Steyr
 Kompakt: 360, 370, 375



29414 Kupplungsscheibe sinter ~~144,90~~
 4 Beläge, 22x25, Z = 10 **120,80**
 verwendbar anst. von:
 47134874, 47134882, 5176450
 passend zu Steyr -Kompakt: 360,370,
 375,485,495,4065,4075,4085



Ausrücklager

Nr. Bezeichnung €
 63034 Drucklager ~~106,90~~
 AD = 75/79,4 mm **89,10**
 ID = 34,6 mm
 H = 21 mm
 passend zu Steyr T80, T84, T86



55990 Ausrücklager 40 x 73 mm ~~83,90~~
 verwendbar anstelle von: 1209160725 **69,90**
 passend zu 188,190
 Deutz, Güldner, Holder, Landini,
 Lindner, MF, O&K ältere Modelle



91992 Feder zu Ausrücklager 55990 ~~9,50~~
7,90



55991 Ausrücklager Fahrkupplung ~~66,90~~
 65 x 96 mm **55,80**
 passend zu 8045,8055,8060,8065,
 8070,8075,8080,8090,942,948,958,
 955,964,970,968,975,9078,9086,9040



55992 Ausrücklager Zapfwellenkupplung ~~105,90~~
 106 x 140 mm **88,30**
 passend zu 8045,8055,8060,8065,
 8070,8075,8080,8090,942,948,958,955,
 964,970,968,975,9078,9086,9040



55993 Ausrücklager 65 x 103 mm ~~71,90~~
 passend zu 50,650,658,760,768,
 8100,8110,8120,8130 **59,90**



55992 Ausrücklager 100 x 57 mm, ~~148,90~~
 57 x 75 mm **124,10**
 verwendbar anstelle von:
 6094211, 500021120
 passend zu Plus: 60, 295,
 658, 760, 768;



55997 Ausrücklager 75 x 117mm ~~189,00~~
 passend zu 988-1300 **157,50**



55994 Ausrücklager 50 x 85 mm ~~42,90~~
 passend zu Plus 40, T290 **35,80**



55949 Ausrücklager ID 106 mm ~~269,00~~
 Sachs Ausführung innendrehend **224,20**
 passend zu 8055/8075



Klimakompressor

Nr. **Bezeichnung** **€**
90305 Klimakompressor 12V **329,00**
 Ø = 112 mm, **274,20**
 Poly-V4,
 Öl 200 cm³,
 Sanden 7H15
verwendbar anstelle von:
 87802912
passend zu Profi 4100, 4110,
 4115, 4120, 4130, 6115,
 6125, 6135, 6140;



90306 Klimakompressor **359,00**
verwendbar anstelle von: **299,20**
 3405689c3, 850873N,
 5176185, 5811103
passend zu Steyr CVT 485, 495,
 6140, 6150, 6175, 6195,
 Kompakt 360, 370, 375, 485, 495;



63210 Klimakompressor **349,00**
verwendbar anstelle von: **290,80**
 5811103, 32233200
passend zu Steyr:
 Kompakt: 360, 370, 375



Ersatzteile zu Klima

Nr. **Bezeichnung** **€**
90678 Absperrhahn **119,00**
verwendbar anstelle von: **99,20**
 1694047M1, 134684047
passend zu Steyr: 8060, 8070,
 8080, 8090, 8100, 8120,
 CVT: 120, 130, 150, 170



90935 Druckschalter Klimaanlage **89,00**
verwendbar anstelle von: **74,20**
 84233818, 87699591
passend zu Steyr CVT 6165,
 6180, 6200, 6210, 6225,
 Profi 4100, 4110, 4115,
 4120, 4130, 6115, 6125,
 6135, 6140



90936 Druckschalter Klimaanlage **94,70**
verwendbar anstelle von: **76,40**
 87000227
passend zu Steyr CVT 6140,
 Profi 4110, 4115, 4120, 4130,
 6115, 6125, 6135, 6140;



90852 Lüftermotor **389,00**
verwendbar anstelle von: **324,20**
 82033102, 87663955
passend zu Steyr Profi 4100,
 4110, 4115, 4120, 4130, 6115,
 6125, 6135, 6140



Nr. **Bezeichnung** **€**
90853 Thermostat **74,90**
verwendbar anstelle von: **62,40**
 134784288, 47131282,
 87377466, 134784258
passend zu Steyr CVT 6140, 6150,
 6160, 6165, 6175, 6180, 6195, 6200,
 6210, 6225, Kompakt 360, 370, 375,
 485, 495, 4065, 4075, 4085, 4095,
 MT 9080, 9085, 9090, 9095, 9100,
 9105, Profi 4110, 4120, 4130,
 6115, 6125, 6140;



63046 Lüftermotor **599,00**
verwendbar anstelle von: **499,20**
 354304A1
passend zu Steyr
 942, 948, 955, 964, 970



62597 Gebläsemotor **268,90**
verwendbar anstelle von: **224,10**
 47108781, 134684473
passend zu Steyr: 9078,
 9083, 9094, 9080, 9090,
 9100, 9105, 9115, 9125, 9145
 CVT: 120, 130, 150, 170,
 6135, 6145, 6155, 6170,
 6190, 6195



97305 Lüftermotor **149,00**
verwendbar anstelle von: **124,20**
 134784252, 3302177M91
passend zu Steyr CVT:
 6140, 6150, 6160, 6175,
 6195 MT: 9080, 9085,
 9090, 9095, 9100,
 9105



Aktion!

Putzpapierrollen

je 2 Stück

Nr.: **Bezeichnung**
 02234K Putzpapierrolle
 26 cm
 800 Abrisse



2 Stück

€18,90

86122K Putzpapierrolle
 blau
 3-lagig
 1000 Abrisse



2 Stück

je 2 Stück

€65,90

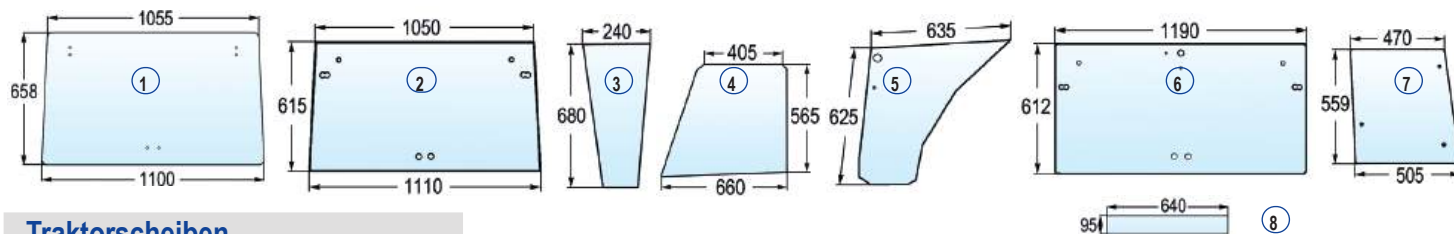

Traktorscheiben

passend zu Steyr M 942, 948, 955, 958, 963, 968, 975

Nr.	Bezeichnung	Pos.	verwendbar anstelle von	Bemerkung	€	
60400	Frontscheibe	1	134571001		118,90	99,10
90813	Frontscheibe	2	134571406	ausstellbar	105,90	88,30
90811	Frontscheibe re./li. unten	3	134571405		32,90	27,40
90810	Türscheibe re./li. oben	4	134771737		54,90	45,80
77344	Türscheibe unten	5	134703118		63,90	53,30
52910	Heckscheibe	6	134568074, 134771735		79,90	68,90
90812	Seitenscheibe re./li.	7	134703168, 134771725		53,90	44,90
60399	Heckscheibe unten	8	134703126, 134568349		29,90	24,90

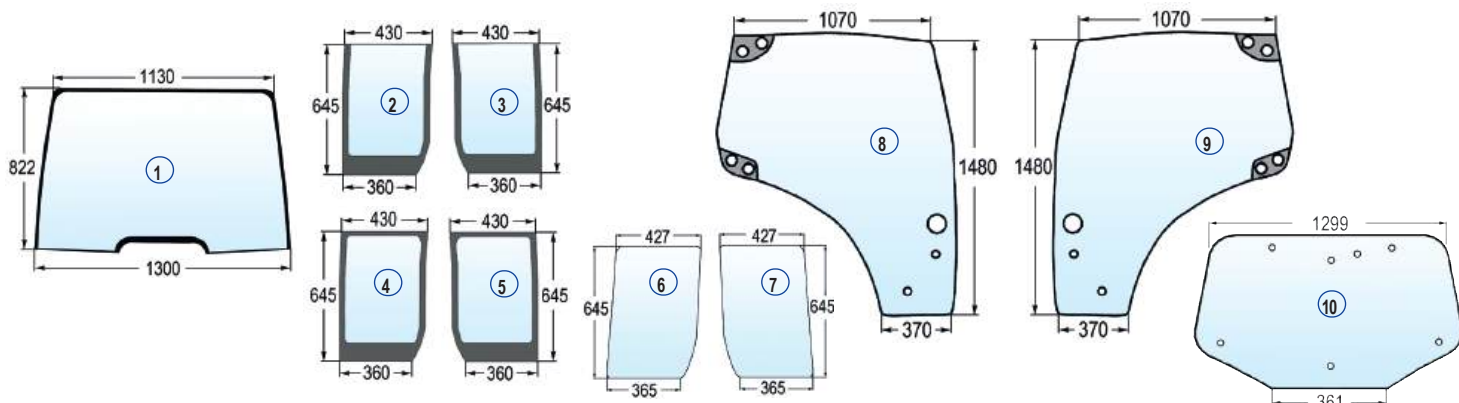

passend zu Steyr Profi: 4100, 4110, 4115, 4120, 4130, 6115, 6130, 6125, 6135, 6140, 6145, 6160, 6165, 6170, 6180, 6185, 6200, 6210, 6215, 6225, 6230

Nr.	Bezeichnung	Pos.	verwendbar anstelle von	Bemerkung	€	
94545	Frontscheibe	1	87304257		199,00	165,80
92519	Frontscheibe re. unten	2	82030485		93,50	77,90
92520	Frontscheibe li. unten	3	82030486		93,50	77,90
92521	Frontscheibe re. unten	4	82030487, 87566891	ausstellbare Frontscheibe	78,60	65,50
92522	Frontscheibe li. unten	5	82030488, 87566892	ausstellbare Frontscheibe	78,60	65,50
98219	Frontscheibe re. unten	6	87304259		85,90	71,60
98220	Frontscheibe li. unten	7	87304261		85,90	71,60
90268	Türscheibe re.	8	87560791, 82027356, 87528172		274,90	229,10
90269	Türscheibe li.	9	87560786, 82027357, 87530786		274,90	229,10
77343	Heckscheibe	10	82014988, 82030887, 87663400, 87744542		178,90	149,10

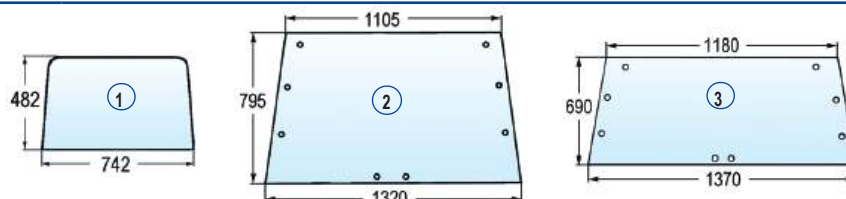

passend zu Steyr Plus Serie: 40,50,60,540,545,548,550,760,768

Nr.	Bezeichnung	Pos.	verwendbar anstelle von	Bemerkung	€	
52635	Frontscheibe	1	9371003		66,90	55,80
90800	Heck-Frontscheibe	2	520594		169,00	140,80
90797	Heckscheibe	3	520590		125,90	104,10

passend zu Steyr 1090, 1100, 1200, 1400, Plus 430, 540, 545, 548, 650, 658, 760, 768, 870, 980, 988;

Traktorscheiben

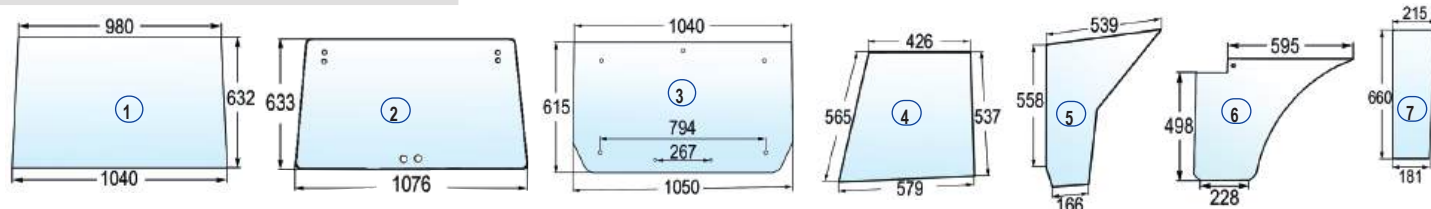

passend zu Steyr Kabine RS-1 Serie: 8055, 8065, 8075

Nr.	Bezeichnung	Pos.	verwendbar anstelle von	Bemerkung	€
52637	Frontscheibe	1	134471001		78,90 65,80
52639	Frontscheibe	2	134471021		134,90 112,40
92013	Heckscheibe	3	134701476, 13473215	RS1 Kabine	134,90 112,40
92014	Türscheibe oben	4	134701030	RS1 Kabine	91,70 76,40
92015	Türscheibe unten	5	134701029	RS1 Kabine	79,90 66,60
92503	Türscheibe unten	6	134701876		81,90 68,30
92018	Frontscheibe re./li. unten	7	134471002	RS1/2 Kabine	29,90 24,90

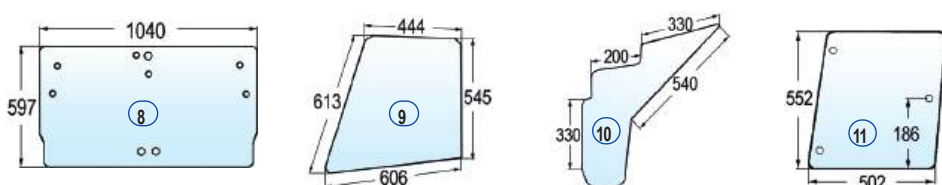

passend zu Steyr RS 2 8055, 8065, 8075, 8087

52667	Heckscheibe	8	134701576		84,90 70,80
92016	Türscheibe oben	9	134701481, 134701595	RS2 Kabine	88,90 74,10
92017	Türscheibe unten	10	134701596, 134701482	RS2 Kabine	98,90 82,40
52656	Seitenscheibe	11		LUG-E	62,90 52,40

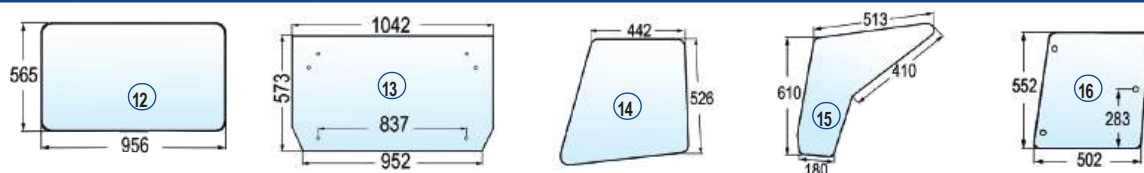

passend zu Steyr Kabine Mauser 8055, 8065, 8075, 8085

52636	Frontscheibe	12	00044250	Mau-4	108,90 90,80
92012	Heckscheibe	13	4-80200250	Mau-4	128,90 107,40
92010	Türscheibe oben	14	4-80200710	Mau-4	68,90 57,40
92011	Türscheibe unten	15	80200711	Mau-4	79,50 66,30
52653	Seitenscheibe	16	80200420	Mau-4	72,90 60,80

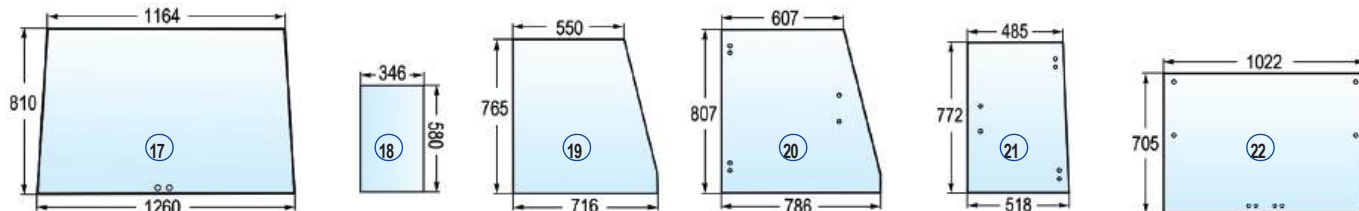

passend zu Steyr 8140, 8150, 8160, 8170

92504	Frontscheibe	17	134171021		119,90 99,20
92505	Frontscheibe re./li. unten	18	134171002		46,90 39,10
92506	Türscheibe li. oben	19	134171005		68,90 57,40
92507	Seitenscheibe re. vorne	20	134171003		93,90 78,30
92510	Seitenscheibe re./li. hinten	21	134171004		71,90 59,20
92508	Heckscheibe	22	134171046		108,90 90,80

Traktorscheiben

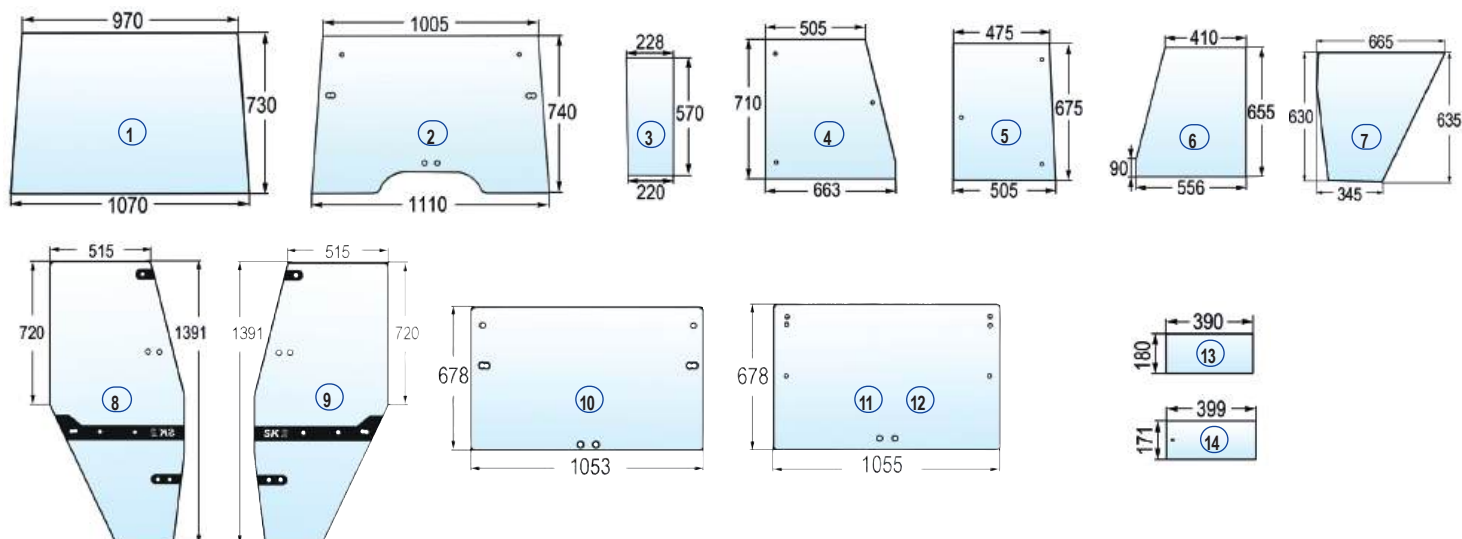

passend zu Steyr Kabine SK1 und 2: 8060, 8070, 8080, 8090, 8110, 8120, 8130

Nr.	Bezeichnung	Pos.	verwendbar anstelle von	Bemerkung	€	
52914	Frontscheibe klar	1	134271084, 134371094	fest	99,90	83,30
52640	Frontscheibe	2	134171145	ausstellbar	104,90	87,40
90808	Frontscheibe re./li. unten	3	134171082		49,90	41,60
52648	Seitenscheibe re. vorne	4	134371113	getönt	81,90	68,30
52651	Seitenscheibe re. vorne	4	134171113	klar	78,90	65,80
52645	Seitenscheibe re./li.	5	134171112	klar	64,90	54,10
52642	Seitenscheibe re./li.	5	134371112	SK-2 Kabine, getönt	65,90	54,20
52912	Türscheibe li. oben	6	134171085	SK-1 Kabine	57,90	48,30
90809	Türscheibe re. unten	7	134171104		116,90	97,40
51360	Türscheibe re.	8	134221003	SK-2 Kabine	136,90	114,10
51361	Türscheibe li.	9	134721011, 134221004	SK-2 Kabine	136,90	114,10
52665	Heckscheibe	10	134171115	SK-2 Kabine	75,90	64,90
52662	Heckscheibe	11	134371087	SK-1 u. SK-2 Kabine	87,90	73,30
60484	Heckscheibe	12	134171097	getönt	140,90	92,40
92502	Heckscheibe unten	13	134771205		38,50	32,10
92501	Heckscheibe unten	14	134771206	ausstellbar	38,50	32,10

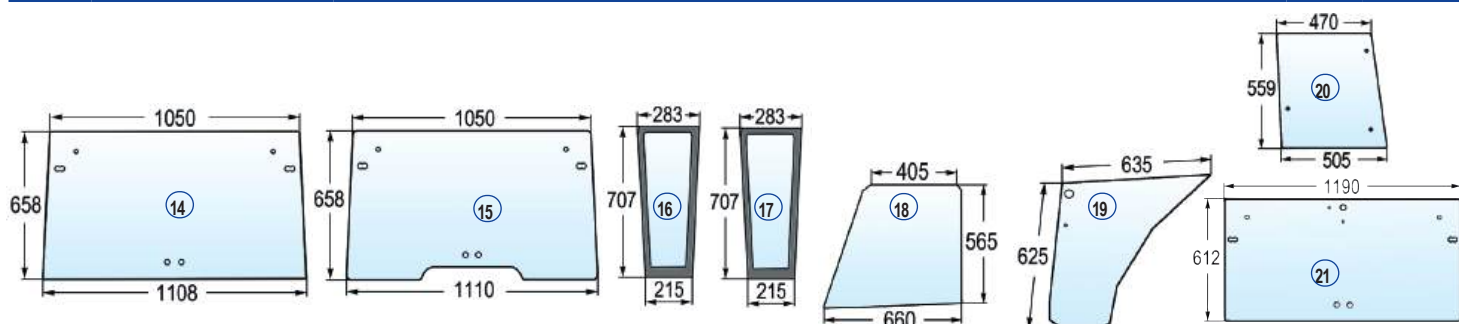

passend zu Steyr Kabine M: 968, 975;

92511	Frontscheibe	14	134571301	ESG, ausstellbar	128,90	107,40
92512	Frontscheibe	15	134571605	ESG, ausstellbar mit Aussparung	124,90	104,10
92514	Frontscheibe re. unten	16	134571604		51,90	43,30
92515	Frontscheibe li. unten	17	134571603		51,90	43,30
90810	Türscheibe re./li. oben	18	134771737	getönt	54,90	45,80
77344	Türscheibe re./li. unten	19	134703118		63,90	53,30
90812	Seitenscheibe re./li.	20	134703168, 134771725		53,90	44,90
52910	Heckscheibe	21	134568074, 134771735		79,90	68,90

Traktorscheiben

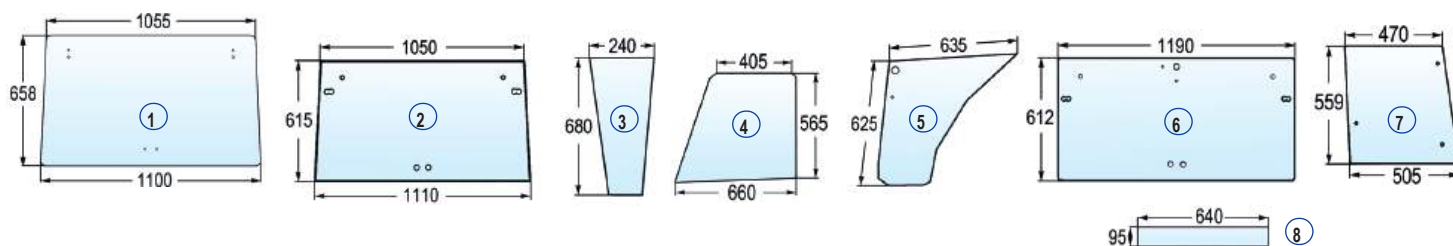

passend Steyr M 942, 948, 955, 958, 963, 964, 968, 970, 975

Nr.	Bezeichnung	Pos.	verwendbar anstelle von	Bemerkung	€
60400	Frontscheibe	1	134571001		118,90 99,10
90813	Frontscheibe	2	134571406	ausstellbar	105,90 88,30
90811	Frontscheibe re./li. unten	3	134571405		32,90 27,40
90810	Türscheibe re./li. oben	4	134771737		54,90 45,80
77344	Türscheibe re./li. unten	5	134703118		63,90 53,30
52910	Heckscheibe	6	134568074, 134771735		79,90 68,90
90812	Seitenscheibe re./li.	7	134703168, 134771725		53,90 44,90
60399	Heckscheibe unten	8	134703126, 134568349		29,90 24,90

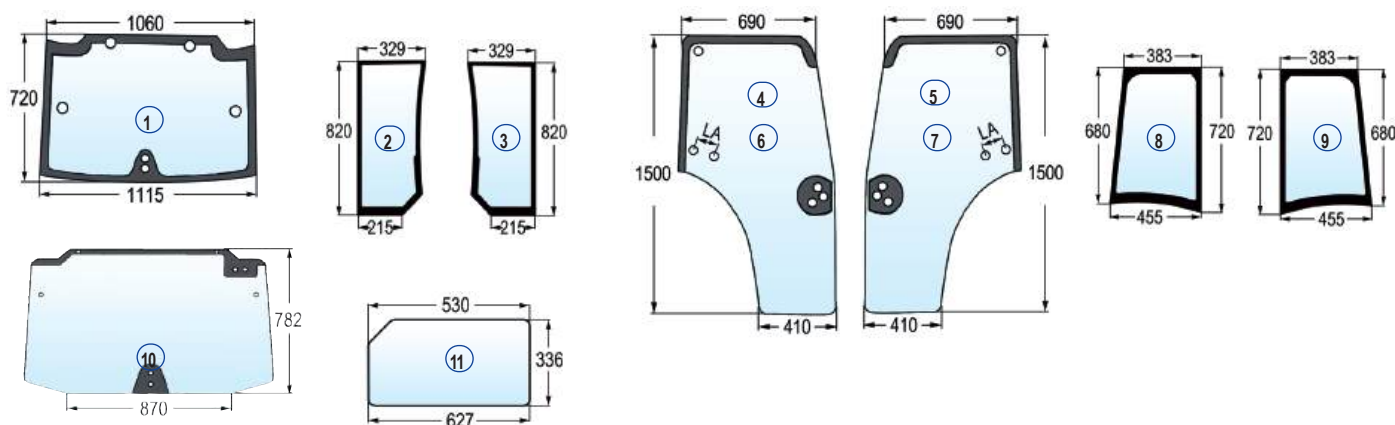

passend Steyr Kompakt: 360, 370, 375, 485, 495, 4065, 4075, 4085, 4095;

Nr.	Bezeichnung	Pos.	verwendbar anstelle von	Bemerkung	€
90790	Frontscheibe	1	44911501		194,10 161,80
60894	Frontscheibe re. unten	2	44911514		86,90 72,40
60895	Frontscheibe li. unten	3	44911515		86,90 72,40
90791	Türscheibe re.	4	44910452	Lochabstand (LA) Türgriff 115 mm	174,90 145,80
90792	Türscheibe li.	5	44910453	Lochabstand (LA) Türgriff 115 mm	174,90 145,80
94741	Türscheibe re.	6	87301767	Lochabstand (LA) Türgriff 85 mm	165,90 138,30
94742	Türscheibe li.	7	87301768	Lochabstand (LA) Türgriff 85 mm	165,90 138,30
60896	Seitenscheibe re.	8	47130822	geklebt	80,90 67,40
60897	Seitenscheibe li.	9	47130823, 87352417	geklebt	80,90 67,40
90793	Heckscheibe	10	44911502		148,90 124,10
60893	Heckscheibe unten	11	44911518		54,90 45,80

Traktorscheiben

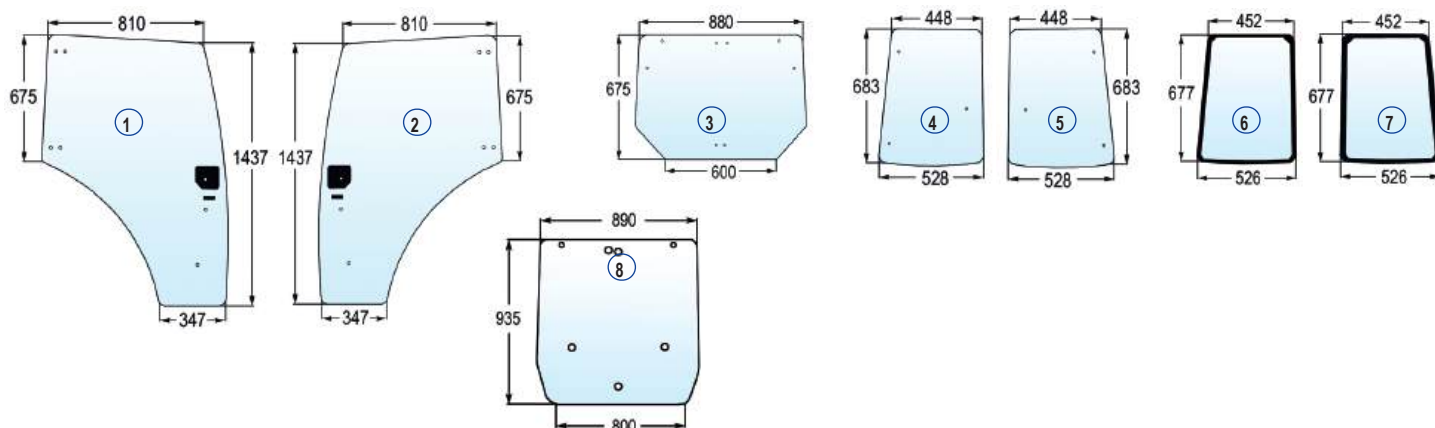

passend zu Steyr Kabine Farmall Kompakt: 4055, 4055S, 4065, 4065S, 4075, 4085, 4095, 4105, 4115 Multi: 4095, 4100, 4105, 4115, 4120

Nr.	Bezeichnung	Pos.	verwendbar anstelle von	Bemerkung	€	€
60384	Türscheibe re.	1	84224131		184,90	154,10
60385	Türscheibe li.	2	84224132		184,90	154,10
60379	Heckscheibe	3	84224148		139,80	116,50
60380	Eckscheibe re.	4	84224146	ausstellbar	99,00	82,50
60381	Eckscheibe li.	5	84224147	ausstellbar	99,00	82,50
60382	Eckscheibe re.	6	84266109	fest	99,60	83,00
60383	Eckscheibe li.	7	84266111	fest	99,60	83,00
61236	Heckscheibe	8	84327955		194,90	162,40

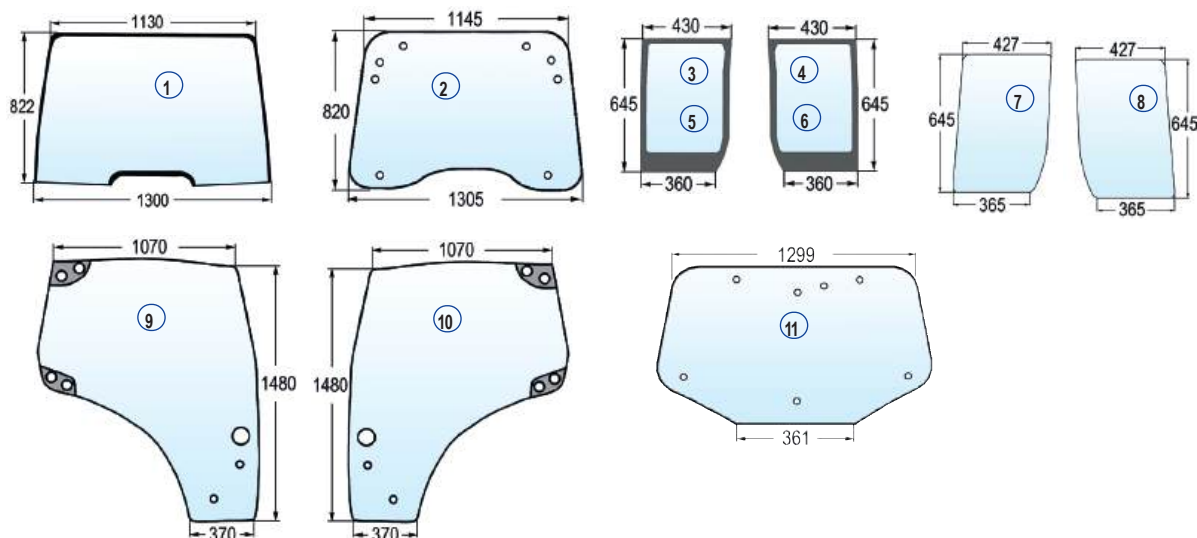

passend zu Steyr Profi: 4100, 4115, 6115, 6125, 6135, 6140, 6145, 6160, 6165, 6170, 6180, 6185, 6200, 6210, 6215, 6225, 6230;

Nr.	Bezeichnung	Pos.	verwendbar anstelle von	Bemerkung	€	€
94545	Frontscheibe	1	87304257		199,00	165,80
90815	Frontscheibe	2	82032042		319,00	265,80
92519	Frontscheibe re. unten	3	82030485		93,50	77,90
92520	Frontscheibe li. unten	4	82030486		93,50	77,90
92521	Frontscheibe re. unten	5	82030487, 87566891	ausstellbare Frontscheibe	78,60	65,50
92522	Frontscheibe li. unten	6	82030488, 87566892	ausstellbare Frontscheibe	78,60	65,50
98219	Frontscheibe re. unten	7	87304259		85,90	71,60
98220	Frontscheibe li. unten	8	87304261		85,90	71,60
90268	Türscheibe re.	9	87560791, 82027356, 87528172		274,90	229,10
90269	Türscheibe li.	10	87560786, 82027357, 87530786, 87528171		274,90	229,10
77343	Heckscheibe	11	82014988, 82030887, 87663400		478,90	149,10

Traktorscheiben

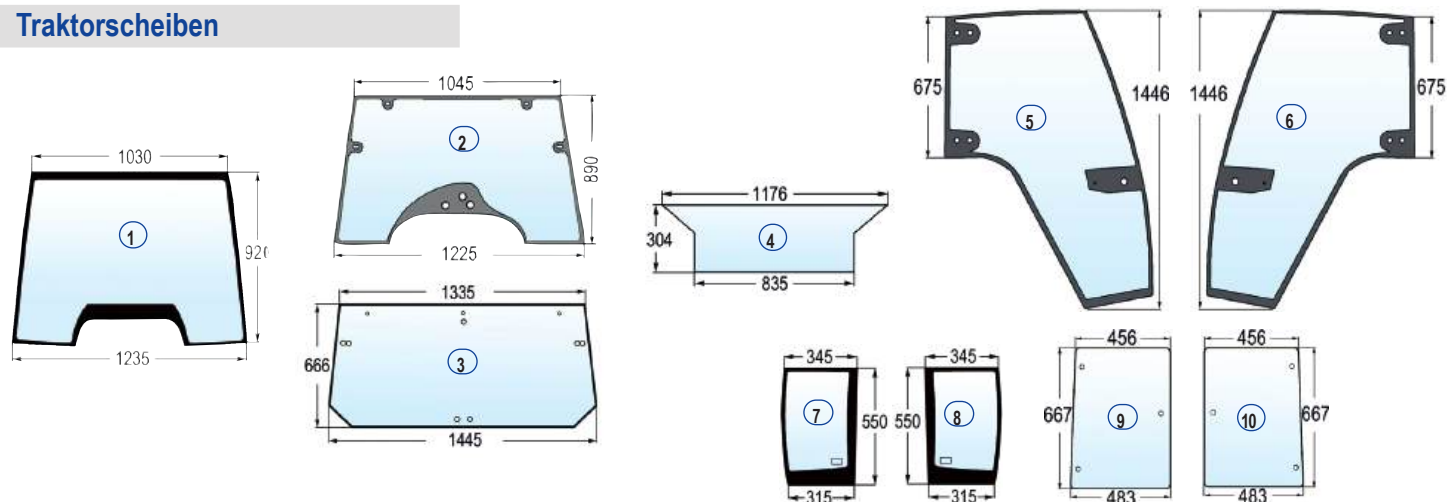

passend zu Steyr M: 9078, 9080, 9083, 9086, 9090, 9094, 9100, 9105, 9115, 9125, 9145, CVT: 120, 130, 150, 170, 6135, 6140, 6145, 6150, 6155, 6160, 6170, 6175, 6190, 6195

Nr.	Bezeichnung	Pos.	verwendbar anstelle von	Bemerkung	€
60481	Frontscheibe fest	1	134671067, 134671001, 134671097, 47108762, 47110837		225,20 187,70
90814	Frontscheibe	2	134671090, 134671060, 47110838	ausstellbar	139,90 115,80
52911	Heckscheibe	3	134671049, 134671061, 134671062, 134671072, 134671091, 134671092, 47110842		94,90 79,10
77340	Heckscheibe unten	4	134671086, 47110486		72,90 60,80
77131	Türscheibe re.	5	134621091, 134621081, 47110845		168,90 140,80
77132	Türscheibe li.	6	134621080, 134621090, 134621001, 47110844		168,90 140,80
92518	Frontscheibe re. unten	7	134671002, 134671069, 134671099, 47110839, 4718764	geklebt	65,30 54,40
92517	Frontscheibe li. unten	8	134671070, 134671080, 134671003, 47110840, 47108765	geklebt	65,30 54,40
77133	Seitenscheibe re.	9	134671085	Serie 9000	48,90 40,80
77134	Seitenscheibe li.	10	134671084	Serie 9000	48,90 40,80

Scheibenwischer

Nr.	Bezeichnung	€
12723	Wischermotor 12V 85° konische Aufnahme A = 42 mm	68,90 57,40
01340	Wischermotor 12V 105° konische Aufnahme A = 46 mm	68,90 57,40
01311	Wischerarm L = 400/500 verstellbar konische Aufnahme	16,90 14,10
01283	Wischerblatt L = 400 mm zu 01311	8,90 7,40
01284	Wischerblatt L = 500 mm zu 01311	8,90 7,40
12459	Wischermotor 12V 110° zylindrische Aufnahme	67,90 56,60
01308	Wischerarm L = 300/400 verstellbare zylindrische Aufnahme	17,90 14,90



Nr.	Bezeichnung	€
52907	Wischermotor 12V, 135°, Achse A8-M6 ohne Schalter, mit Parkstellung, Achsabstand 57 mm, Befestigung in der Scheibe unten verwendbar anstelle von: 403045, 04363241, 01175799 passend zu Steyr Serie 80	159,90 133,30
80671	Wischermotor verwendbar anstelle von: 0390216713, 0390216739 passend zu Steyr 8055, 8060, 8065, 8070, 8075, 8080, 8085, 8080, 8090, 8100, 8110, 8120, 8130	164,90 137,40
90854	Wischermotor verwendbar anstelle von: 87701494, 82030991 passend zu Steyr CVT 6130, 6160, 6165, 6170, 6180, 6185, 6200, 6210, 6215, 6225, 6230, Profi 4100, 4110, 4115, 4120, 4130, 6115, 6125, 6135, 6140	228,90 190,80
93957	Wischermotor 12V, 180°, Achse A10-M8 mit Parkstellung Rechts hängend, 61,5 mm Achslänge, eintourig 45 U/min-1 verwendbar anstelle von: 134674004, 04413192, 404033 passend zu Steyr 6135CVT, 6140CVT, 6145CVT, 6150CVT, 6155CVT, 6160CVT, 6170CVT, 6175CVT, 6190CVT, 6195CVT, 942, 948, 955, 964, 970, 9078, 9086, 9094, 9105, 9115, 9125, 9145, 9080M, 9090M, 9100M, 9080MT, 9085MT, 9090MT, 9095MT, 9100MT, 9105MT, CVT: 120, 130, 150, 170 M: 948, 952, 958, 963, 968, 975, 9078, 9083, 9086, 9094	258,90 215,80



Nr.	Bezeichnung	€
57687	Scheibenwaschanlage Kunststoffbehälter 2 Liter mit Pumpe 12V	30,80 25,70



80664	Scheibenwaschanlage Set Inhalt: 1,2 l mit Pumpe, Düsen, Schalter, Halterung und Zubehör	28,90 24,10
-------	--	----------------------------------



Dichtungen und Kantenschutz

Nr.	Bezeichnung	€
52687	Gummi-Klemmprofil Blech 1,2 mm	12,20 10,20
52699	Gummi-Klemmprofil Blech 3-4 mm	12,90 10,80
86923	Gummi-Klemmprofil Blech 5 mm	14,70 12,30

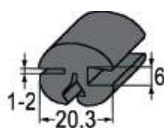

52689	Füller	2,90 2,40
-------	--------	--------------------------------

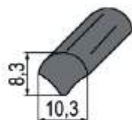

52692	Kantenschutzprofil 1 - 4 mm Klemmbereich	3,90 3,30
-------	---	--------------------------------

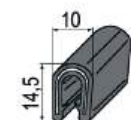

52703	Dichtungsprofil 1 - 4 mm Klemmbereich	6,90 5,80
-------	--	--------------------------------



52705	Dichtungsprofil 5 - 6 mm Klemmbereich	8,90 7,40
-------	--	--------------------------------

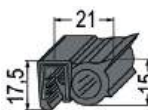

90210	Matte für Kabinenboden passend zu Steyr Serie 80	258,90 228,90
-------	---	------------------------------------



Türgriffe und Schlösser

Nr.	Bezeichnung	€
52670	Scharnier verwendbar anstelle von: 34135108	10,90 9,10



16657	Stützscheibe Innenloch-Ø: 8,5 mm Außen-Ø: 38,5 mm	2,50 2,10
-------	---	--------------------------------



16651	Gummischeibe verwendbar anstelle von: 34135064 Innenloch-Ø: 14 mm Außen-Ø: 41 mm	0,90 0,80
-------	---	--------------------------------



16680	Gummiöse für Glasscheiben Glasloch ca. 19 mm, Innenloch 14 mm	1,00 0,80
-------	---	--------------------------------



16681	Distanzhülse für Glasscheibe AD = 14 mm, ID = 8 mm, H = 13 mm	0,60 0,50
-------	---	--------------------------------



Nr.	Bezeichnung	€
52711	Universal Fallenschloss	24,90 20,80

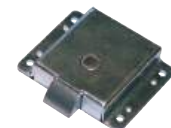

62578	Drücker zu 52711	6,90 5,80
-------	---------------------	--------------------------------



63038	Handgriff Heckscheibe verwendbar anstelle von:	29,90 24,90
-------	---	----------------------------------

52911, 134571204, 134135101
passend zu Steyr: 955, 964, 970, 9078,
9086, 9094, 9105, 9115, 9125, 9145;
CVT: 120, 130, 150, 170, 6135, 6140, 6145,
6150, 6155, 6160, 6170, 6175, 6190, 6195;
M: 948, 952, 958, 963, 968, 975, 9078,
9080, 9083, 9086, 9090, 9094, 9100;
MT: 9080, 9085, 9090, 9095, 9100, 9105



90844	Türschloss re. verwendbar anstelle von: 624128 passend zu Fritzmeier diverse Typen	47,90 39,90
-------	---	----------------------------------



93893	Gegenplatte re. zu 90844	6,50 5,40
-------	-----------------------------	--------------------------------

90845	Türschloss li. verwendbar anstelle von: 624129 passend zu Fritzmeier	47,90 39,90
-------	--	----------------------------------



93894	Gegenplatte li. zu 90845	6,80 5,70
-------	-----------------------------	--------------------------------

96879	Türgriff re./li. verwendbar anstelle von: 134621042 passend zu Steyr: CVT: 120, 130, 150, 170, 6135, 6145, 6155, 6170, 6190, 6195, 9078, 9080M, 9086, 9090M, 9094, 9100M, 9105, 9115, 9125, 9145 M: 9078, 9083, 9086, 9094	75,50 62,90
-------	--	----------------------------------



93895	Türschloss re. verwendbar anstelle von: 1-34-702-970, AL58548	56,90 47,40
-------	---	----------------------------------



93896	Türschloss li. verwendbar anstelle von: 134702970, AL58549 passend zu Steyr: M: 9080, 9090, 9100, 9080; MT: 9090, 9095, 9100, 9105 M: 942, 948, 952, 955, 958, 963, 964, 968, 970, 975, 9078, 9083, 9086, 9094, 9094	56,90 47,40
-------	---	----------------------------------



96881	Türschloss re. verwendbar anstelle von: 134621053, V45217400, V30317000	43,90 36,60
-------	---	----------------------------------

96882	Türschloss li. verwendbar anstelle von: 134621052, V45217500, V30316900 passend zu Steyr: 9078, 9086, 9094, 9105, 9115, 9125, 9145 CVT: 120, 130, 150, 170, 6135, 6145, 6155, 6170, 6190, 6195 M: 9080, 9090, 9100 M: 9078, 9083, 9086, 9094; Valtra-Valmet: 205, 255, 305, 315, 355, 365, 405, 415, 415M, 455, 465, 555, 565, 665, 700, 800, 900 Mezzo: 6000, 6100, 6200, 6300, 6400, 6600, 6800, 6900 Mega: 8000, 8050, 8100, 8150, 8200, 8400, 8450, 8550, 8750 A: 65, 72, 75, 82, 83, 85, 92, 93, 95 C: 90, 100, 110, 120, 130, 150 M: 120, 130, 150 N: 82, 91, 92, 93, 101, 103, 111, 113, 121, 122, 123, 141, 142, 143, 163 T: 120, 121, 130, 131, 132, 133, 140, 150, 151, 152, 153, 160, 161, 162, 163, 170, 171, 172, 173, 180, 182, 183, 190, 191, 193, 202, 203, 213 X: 100, 110, 120 XM: 130, 150 HI: 6250, 6350, 6550, 6750, 6850, 8050, 8150, 8350, 8450, 8550, 8950	43,90 36,60
-------	---	----------------------------------



Nr. **Bezeichnung** **€**
96883 Türgriff **64,80**
51,50
 verwendbar anstelle von: 134702974
 passend zu Steyr: 942, 948, 955, 964, 970, 9078, 9086, 9094 M: 948, 952, 958, 963, 968, 975, 9078, 9083, 9086, 9094 M: 9080, 9090, 9100 MT: 9080, 9090, 9095, 9100, 9105



90835 Türgriff rechts und links **64,90**
51,60
 verwendbar anstelle von: 82029168



90839 Türschloss re. **66,90**
55,80
 verwendbar anstelle von: 82032407



90840 Türschloss li. **66,90**
55,80
 verwendbar anstelle von: 82032406
 passend zu Steyr Profi 4100, 4110, 4115, 4120, 4130, 6115, 6125, 6135, 6140;

93914 Sonnenblende **59,90**
49,90
 500 x 195 mm
 A = 90 mm



93915 Sonnenblende **59,90**
49,90
 500 x 195 mm
 A = 150 mm



61656 Druckspeicher **498,90**
165,80
 verwendbar anstelle von: 5195043
 passend zu Steyr: Profi: 4110,4115, 4120,4125,4130,4135,4145,6125 6140, 6145, CVT: 6165, 6170, 6180,6185,6200, 6205,6210,6215,6220,6225,6230,6240 Terrus CVT: 6270, 6300;



94572 Kabinenlager **49,60**
41,30
 Lochabstand = 120 mm
 verwendbar anstelle von: 5132016
 passend zu Steyr Kompakt: 360, 370, 375, 495, 4085;



90831 Kabinenlager vorne und hinten **68,90**
57,40
 Höhe = 47 mm
 Lochbild = 55 x 116 mm
 verwendbar anstelle von: 134641006
 passend zu Steyr 9105, 9115, 9125, 9145, CVT120,130,150,170, M9078, 9083, 9086, 9094, 948, 958, 952, 963, 968, 975



90656 Kabinenlager vorne und hinten **84,90**
68,30
 H = 50 mm,
 Lochbild = 65 x 80 mm
 verwendbar anstelle von: 3712693M1, 4233948M1, 3715926M1, 134141099, 134141100
 passend zu Steyr: 942,948, 955,964,970,8045,8055,8060, 8065,8070,8075,8080,8085,8090, 8100,8110,8120,8130,8140,8165, 8170,8180



Gasdruckfedern

Nr. **Bezeichnung** **€**
52761 Gasdruckfeder **20,40**
17,00
 zu Frontscheibe
 verwendbar anstelle von: 99976048
 passend zu 8060



86240 Gasdruckfeder **22,00**
18,30
 zu Frontscheibe
 verwendbar anstelle von: 44910537
 passend zu Steyr Kompakt 360,370,375



86243 Gasdruckfeder **20,90**
17,40
 zu Frontscheibe
 verwendbar anstelle von: 82022475
 passend zu Steyr: Profi 4100,4115, 6115,6125,6135



86246 Gasdruckfeder **24,90**
18,30
 zu Frontscheibe
 verwendbar anstelle von: 199976064
 passend zu Steyr 942,948,955,964,970

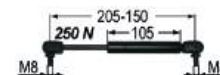

76733 Gasdruckfeder **24,70**
18,10
 zu Frontscheibe
 verwendbar anstelle von: 199976065
 passend zu Steyr M948,952,963,968, 975,8075,9078,9083,9086,9105,9115, 9125,9145 CVT 120, 130, 150, 170, 6135, 6145,6155, 9170, 6190, 6195



86227 Gasdruckfeder **23,90**
19,90
 zu Motorhaube
 verwendbar anstelle von: 65421013,199976069
 passend zu Steyr 9105



52763 Gasdruckfeder **22,90**
19,10
 zu Türe
 verwendbar anstelle von: 34701485
 passend zu 8045,8055,8065,8075 mit RS2 Kabine



52765 Gasdruckfeder **22,90**
19,10
 zu Türe
 verwendbar anstelle von: 99976060
 passend zu Serie 80 mit SK2 Kabine



52901 Gasdruckfeder zu Türe **20,90**
17,40

63277 Gasdruckfeder Türe Stabilus **34,90**
26,60
 verwendbar anstelle von: 199976061
 passend zu Steyr 9078,9083,9086, 9094,9105,9115,9125,9145; CVT 120,130,150,170



86241 Gasdruckfeder zu Türe **20,90**
17,40
 verwendbar anstelle von: 5191712
 passend zu Kompakt 360,370,375



86245 Gasdruckfeder zu Türe **24,90**
18,30
 verwendbar anstelle von: 87374182
 passend zu Profi 4100,4110,4115, 4120,4130,6115,6125,6130,6135,6140 CVT 6165,6180,6200,6210,6225



86242 Gasdruckfeder zu Türe **23,90**
19,90
 verwendbar anstelle von: 82036216,82032040
 passend zu Profi 4100,4115, 6115,6125,6135



52767 Gasdruckfeder zu Tür u. Heckscheibe **20,90**
17,40
 verwendbar anstelle von: 34701577
 passend zu Serie 900 mit Duo Kabine, M948,M958,M952,M963,M968,M975, 9078,9086,9094,M9078,M9083,M9086, M9094,9105,9115,9125,9145,CVT120, CVT130,CVT150,CVT170

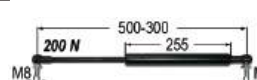

Nr.	Bezeichnung	€
52769	Gasdruckfeder zu Heckscheibe verwendbar anstelle von: 99976005 passend zu Serie 80 mit FK1 Kabine, 8140,8150,8170	20,90 17,40
09222	Gasdruckfeder zu Heckscheibe verwendbar anstelle von: 99976047 passend zu Serie 80 mit SK2 Kabine	17,90 14,90
52772	Gasdruckfeder zu Heckscheibe verwendbar anstelle von: 34701526 passend zu 8060, 8085 Schmalspur 8060, 8090 Kommunal	20,40 17,00
76732	Gasdruckfeder zu Heckscheibe verwendbar anstelle von: 5192009 passend zu Kompakt 360,370,375	20,90 17,40
52774	Gasdruckfeder zu Heckscheibe verwendbar anstelle von: 99976051 passend zu Steyr: M948,952,963,968, 975,8075,9078,9083,9086,9105,9115, 9125,9145, CVT 120,130,150,170, 6135,6145,6155,9170,6190,6195	20,90 17,40
86237	Gasdruckfeder zu Heckscheibe verwendbar anstelle von: 82019393 passend zu Profi 4100,4115,6115, 6125,6135;	21,90 18,30
09223	Gasdruckfeder zu Dachluke verwendbar anstelle von: 99976036 passend zu Serie 80	20,90 17,40
86249	Gasdruckfeder zu Dachluke verwendbar anstelle von: 199976062 passend zu 9078,9083,9086,9094 9105,9115,9125,9145; CVT 120,130,150,170	20,90 17,40

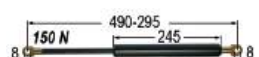

Anschlüsse zu Gasdruckfedern

Nr.	Bezeichnung	IG	AG	€
53938	Kugelgelenk	M6	M8	2,50 2,10
53939	Anschluss	M6	Ø 8 mm	3,10 2,60
77723	Befestigungsplatte mit Zapfen Ø 8 mm, LA = 55 mm			5,20 4,30
93830	Befestigungsplatte mit Kugel Ø = 10 mm, LA = 55 mm			5,20 4,30
93829	Winkelblech mit Zapfen Ø = 10 mm, LA = 40 mm			5,60 4,70
93828	Winkelblech mit Kugel Ø = 10 mm, LA = 40 mm			5,20 4,30
77724	Anschlussbügel LA = 75 mm			3,10 2,60
86038	Befestigung			7,90 6,60
86037	Befestigung			5,90 4,90



Fahrzeugspiegel

Nr.	Bezeichnung	€
52718	Spiegel für Stange Ø = 10 mm rund Ø = 123 mm	11,90 9,90
87607	Spiegelstange mit Halter	24,90 20,80
60807	Spiegelstange verwendbar anstelle von: 94770019 passend zu Steyr Plus Serie	14,90 12,40
77086	Teleskopspiegelhalter universal kpl. mit Halterung 400 - 620 mm	46,90 39,10
52698	Spiegel 186 x 318 mm für Stange 14-20 mm	27,90 21,90
52701	Ersatzglas 176 x 308 mm	13,50 11,30
97148	Teleskop-Spiegelhalter re. verwendbar anstelle von: 82031211, 82035905, 84398575, 87314382	136,90 113,90
97149	Teleskop-Spiegelhalter li. verwendbar anstelle von: 82031212, 82035906, 87314381 passend zu CVT: 6165, 6180, 6200, 6210, 6225 Profi: 4110, 6125, 6140	136,90 113,90
97150	Spiegel re. beheizt u. elektr. verst. verwendbar anstelle von: 87316908, RE320917, 4289971M92	178,90 149,10
97151	Spiegel li. beheizt u. elektr. verst. verwendbar anstelle von: 87316907, RE320917, 4289971M92	178,90 149,10
97154	Teleskop-Spiegelhalter re./li. verwendbar anstelle von: 134577027 passend zu Steyr: 942, 948, 955, 964, 970	299,80 249,80
64440	Spiegelhalter re. verwendbar anstelle von: 134677083, 134677014, 3006182, E551542	208,90 174,10
64441	Spiegelhalter li. verwendbar anstelle von: 134677082, 134677013, 3006045, E551543 passend zu 9078, M9078, 9080M, M9083, 9085MT; 9086, M9086, 9090M, M9094, 9095MT, 9094, 9100M, 9105, 9105MT, 9115, 9125, 9145, CVT: 120, 130, 150, 170, 6135, 6140, 6145, 6150, 6155, 6160, 6170, 6175, 6190, 6195	208,90 174,10
93877	Spiegel 314 x 226 mm mit 18 mm Schelle verwendbar anstelle von: 134677110, 47111341, 04412581, 01035640, G816810150033, G816810150031, 3006047	32,90 24,90
93878	Spiegel 12V beheizt 314 x 226 mm mit 18 u. 22 mm Spiegel	68,90 57,40
93879	Ersatzglas 300 x 213 mm zu Spiegel 93877 verwendbar anstelle von: 116100770701, 3203832	19,90 16,60
93880	Ersatzglas 12V beheizt 300 x 213 mm zu Spiegel 93878 passend zu CVT: 6135, 6140, 6145, 6150,6160,6170,6175, 6190, 6195, M: 9080,9090,9100, MT: 9085,9095,9105	28,90 24,10



Fahrzeugspiegel

Nr.	Bezeichnung	€
93881	Spiegel 328 x 240 mm mit 15 - 21 mm Schelle verwendbar anstelle von: 82014840, 86010518, 82014587, 297017A1	39,90 33,30
62704	Spiegel 330 x 240 mm mit Gewindebolzen passend zu Steyr -Profi: 4100, 4115, 6115, 6125, 6135;	75,90 63,30
54152	Spiegel 315x225 mit Befestigung 14-20 mm für Teleskoparm passend zu Steyr	44,90 37,40
54153	Ersatzglas zu Spiegel 54152 315 x 225 passend zu Steyr	44,90 12,40
52690	Spiegel 310 x 220 mm für Stange 16-18 mm verwendb. anst. v.: 3104955M1, 04327533, 6821461	58,90 49,10
52693	Ersatzglas 300 x 214 mm passend zu Steyr	44,90 12,40
63477	Haupt-Nahbereichsspiegel 441 x 228 mm • Hauptspiegel (großer Spiegel): L 287 x B 228 mm • Radius Hauptspiegel: 1200 • Nahbereichsspiegel (kleiner Spiegel): 154 x 210 mm • Radius Nahbereichsspiegel: 300 • Befestigungssockel Ø: 15 - 32 mm • Befestigungssockel ist drehbar! verwendbar anst. von: 21D5441710, 42154H3480, 1000386860, 11068341, 3010662, AVC0805960, 1000386860	68,90 57,90
63615	Ersatzglas 287 x 228 mm zu 63477	48,90 15,80
63616	Ersatzglas 154 x 210 mm zu 63477	49,90 16,60
52704	Spiegel 140 x 210, für Stange Ø = 10 mm passend zu Reform Steyr	49,90 16,60
95882	Spiegel 160 x 260 mm für Stange universal - inkl. 3 Einsätze mit ID 10, 14 und 18 mm passend zu Reform Steyr	42,90 9,90
52706	Spiegel 140 x 210, für Stange Ø = 12 mm passend zu Mauser Reform Steyr	25,90 21,60
52708	Spiegel 140 x 250 mm für Stange Ø = 10/12 mm passend zu Mauser	34,90 26,60
53715	Ersatzglas 140 x 250 zu 52708	45,90 13,30
00742	Ersatzspiegel 180 x 230 mm für Stange 18 mm verwendbar anstelle von: 5126233 / 9958752	45,90 13,90



Auspuff

Nr.	Bezeichnung	Länge mm	ID mm	€
52739	Auspufftopf verwendbar anstelle von: 188540122 passend zu T188	475	80	156,90 130,80
52740	Rohr zu Auspufftopf verwendbar anst. von: 188540095 passend zu T188	80		98,90 82,40
52742	Auspufftopf verwendbar anst. von: 190540010 passend zu T190	475	80	144,90 120,80
52743	Rohr zu Auspufftopf verwendbar anstelle von: 190540032 passend zu T190	80		74,90 59,90
52745	Flanschdichtung zu Auspuff verwendbar anstelle von: 900030069307			3,40 2,80
04095	Schalldämpfer verwendbar anst.: 192540091 passend zu Plus Serie 540, 650, 658, 760, 768	1160	73	84,90 70,80
52748	Flanschdichtung zu Auspuff verwendbar anst.: 407110021			2,90 2,40
52746	Schalldämpfer verwendbar anst.: 390540019 passend zu Plus Serie 870,980,1090,1100	1150	73	148,90 124,10
52748	Flanschdichtung zu Auspuff verwendbar anst.: 407110021			2,90 2,40
04062	Schalldämpfer verwendbar anst.: 33700540157 passend zu 8045,8055, 8060,8070,8075, 8080,8090,9090	1280	60	112,90 94,10
52750	Flanschdichtung zu Auspuff			4,30 3,60
52751	Auspuffendrohr gebogen verwendbar anst.: 33700540702 passend zu 8060,8070, 8080,8090 niedrig	210	56	42,90 35,80
52752	Auspuffendrohr gebogen verwendbar anst.: 33700540701 passend zu 8060,8070,8080,8090	450	45	41,90 34,90
97647	Endrohr verwendbar anst.: 133154019KR passend zu 942, 948, 955, 964, 970;	490	56	44,90 37,40

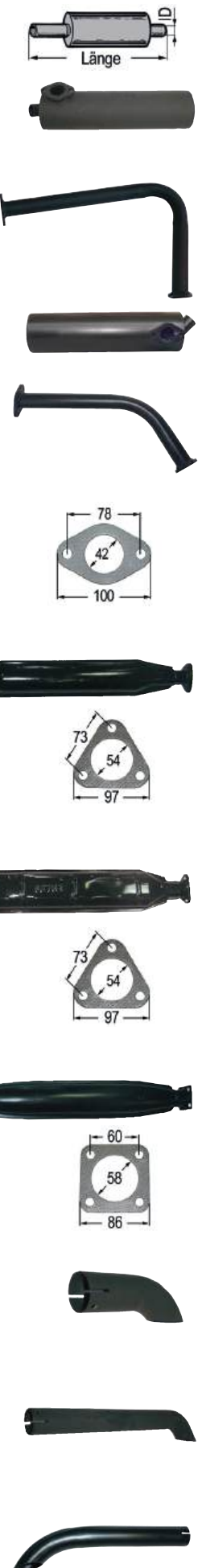

Auspuff

Nr.	Bezeichnung	Länge mm	ID mm	€
65394	Auspuffrohr passend zu Steyr M: 968, 975, 9078, 9083, 9086, 9094, MWM	900	60	84,90 70,80



90783	Schalldämpfer mit Luftabsaugung verwendbar anstelle von: 82027813 passend zu Steyr Profi 4100, 4110, 4115, 4120, 4130;	1720	90	868,90 724,10
-------	--	------	----	------------------------------------



90784	Schalldämpfer mit Luftabsaugung verwendbar anstelle von: 82027824 passend zu Steyr Profi: 6115, 6125, 6135, 6140;	1710	90	389,00 324,20
-------	---	------	----	------------------------------------



90785	Schalldämpfer mit Absaugung verwendbar anstelle von: 87396433, 87311110	1830	90	899,00 749,20
-------	---	------	----	------------------------------------



96027	Auspuffkrümmer L = 1490 mm verwendbar anstelle von: 180450027 passend zu Steyr T180			476,90 147,40
-------	---	--	--	------------------------------------



96029	Auspuffkrümmer L = 1200 mm verwendbar anst. von: 1180N54001 passend zu Steyr T180A, T180N; T182A			479,90 149,90
-------	--	--	--	------------------------------------

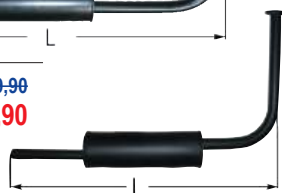

53710	Auspuffkrümmer für 4 Zylinder LA = 84 mm verwendbar anstelle von: 4071100 passend zu Steyr 50, 650,60,760,768			75,90 63,30
-------	---	--	--	----------------------------------



53684	Auspuffkrümmer für 4 Zylinder LA = 84 mm passend zu Steyr 50,650,60,760,768			98,90 82,40
-------	---	--	--	----------------------------------



53709	Anschlusskrümmer für 3 Zylinder passend zu Steyr T190, Plus 40,540,545,548			76,90 64,10
-------	--	--	--	----------------------------------



53683	Auspuffkrümmer für 3 Zylinder passend zu Steyr T190, Plus 40,540,545,548			89,90 74,90
-------	--	--	--	----------------------------------



89701	Auspuffkrümmer verwendbar anstelle von: 41100110010 passend zu Steyr 8070			289,00 240,80
-------	---	--	--	------------------------------------



Nr.	Bezeichnung	€
60928	Auspuffkrümmer verwendbar anst. von: 131185110002 passend zu Steyr 942, 8045, 8065-RS 2	404,90 84,90



53494	Anschlusskrümmer verwendbar anstelle von: 131700540006 passend zu Steyr 942, 955	78,90 65,80
-------	--	----------------------------------



54335	Krümmerdichtung LA = 84 mm passend zu Steyr Serie Plus 4 Zylinder	3,00 2,50
-------	---	--------------------------------



54336	Krümmer Flanschdichtung passend zu Steyr 4080011	2,10 1,80
-------	--	--------------------------------



52745	Krümmer Flanschdichtung LA = 78mm passend zu Serie Plus 3 Zylinder	3,40 2,80
-------	---	--------------------------------

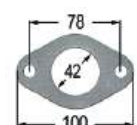

52748	Flanschdichtung zu Auspuff LA= 73 mm verwendbar anstelle von: 407110021	2,90 2,40
-------	--	--------------------------------

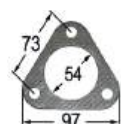

53711	Flanschdichtung LA = 84 mm	2,50 2,10
-------	-------------------------------	--------------------------------



52750	Dichtung zu Auspuff LA = 60 x 60	4,30 3,60
-------	-------------------------------------	--------------------------------



64094	Auspuffkrümmerdichtung verwendbar anst.: 130100110702 2852743, 504081248, 2830445, 130100110701 passend zu 955, 964, M968, 970, M975, 9078, M9078, M9083, 9086, M9086, 9094, M9094	3,20 2,70
-------	--	--------------------------------



Auspuffklappen

Nr.	Bezeichnung	A	€
05639	Auspuffklappe	40-43 mm	13,90 11,60
54334	Auspuffklappe verwendbar anstelle von: 192540051	43-49 mm	13,90 11,60



Lackspray

Nr.	Bezeichnung	€
74543	Lackspray 400ml Thermolack schwarz	14,90 9,90
63162	Lackspray 400 ml RAL 7021 schwarzgrau (Steyr)	6,90 5,80
61897	Lackspray 400 ml RAL 3000 feuerrot (Steyr)	6,90 5,80
63163	Lackspray 400 ml RAL 9018 papyrusweiß (Steyr)	6,90 5,80

